

INSTALLATION, OPERATION & MAINTENANCE MANUAL



**E8KT/E10KT/E12KT
ENERGY STORAGE SYSTEM**

Table of Contents

| | |
|--|-----------|
| 1 ABOUT THIS MANUAL | 3 |
| 1.1 Purpose | 3 |
| 1.2 Intended Audience | 3 |
| 1.3 Conventions..... | 3 |
| 1.4 Change History | 4 |
| 2 SAFETY INSTRUCTIONS | 5 |
| 2.1 Limitation of Liability | 5 |
| 2.2 Warning Signs | 6 |
| 2.3 Battery Safety | 7 |
| 2.3.1 General Instructions..... | 8 |
| 2.3.2 Maintenance of Battery Packs | 9 |
| 2.3.3 Disposal of Battery Packs..... | 9 |
| 2.4 Before Installation..... | 10 |
| 2.5 Installation Safety | 12 |
| 2.6 Operation Safety..... | 14 |
| 2.7 Maintenance Safety..... | 16 |
| 2.8 Disposal Safety..... | 17 |
| 3 PRODUCT INTRODUCTION..... | 18 |
| 3.1 Features | 18 |
| 3.2 Delivery Scope | 18 |
| 3.3 Model..... | 19 |
| 3.3.1 Inverter Model..... | 19 |
| 3.3.2 Battery Pack Model..... | 19 |
| 3.4 Inverter Appearance | 20 |
| 3.4.1 LCD Screen | 20 |
| 3.4.2 Switches | 21 |
| 3.4.3 Ports | 21 |
| 3.5 Battery Pack Appearance | 23 |
| 3.6 Energy Management System (EMS)..... | 25 |
| 3.7 Parallel System..... | 25 |
| 3.8 Scenarios..... | 26 |
| 3.8.1 DC-coupling System | 26 |
| 3.8.2 AC-coupling System | 27 |
| 3.9 Wiring Diagram..... | 29 |

| | |
|--|-----------|
| 3.10 System States | 30 |
| 3.10.1 Inverter States | 30 |
| 3.10.2 Battery Pack States | 31 |
| 3.11 Working Modes..... | 31 |
| 3.11.1 SELF CONSUME | 31 |
| 3.11.2 BAT PRIORITY | 31 |
| 3.11.3 PEAK SHIFT..... | 31 |
| 4 INSTALLATION | 32 |
| 4.1 Checking the Package..... | 32 |
| 4.1.1 Hybrid Inverter Components..... | 33 |
| 4.1.2 Battery Pack Components | 34 |
| 4.1.3 Cables..... | 34 |
| 4.2 Preparing Tools and Instruments..... | 36 |
| 4.3 Installation Position Requirements | 37 |
| 4.3.1 Restrictions | 37 |
| 4.3.2 Clearance Requirements | 38 |
| 4.4 Installing the System | 39 |
| 4.4.1 Mounting Battery Packs..... | 39 |
| 4.4.2 Mounting the Inverter..... | 44 |
| 4.4.3 Connecting Battery Packs (BluE-PACK-5.1-16S-100A-F)..... | 46 |
| 4.4.4 Connecting Battery Packs (BluE-PACK5.1)..... | 52 |
| 4.4.5 Connecting the Inverter and PV Solar Panels | 58 |
| 4.4.6 Connecting to Grid and Loads..... | 59 |
| 4.4.7 Connecting a Stick Logger..... | 65 |
| 4.4.8 Connecting External CTs | 66 |
| 4.4.9 Connecting a Smart Meter..... | 69 |
| 4.4.10 (Optional) Connecting a DRED or an RRCR..... | 71 |
| 4.4.11 (Optional) Connecting a Generator..... | 73 |
| 4.5 Installing a Parallel System | 74 |
| 4.5.1 Wiring of a Parallel System..... | 74 |
| 4.5.2 Installation Prerequisites..... | 75 |
| 4.5.3 Installation Procedure..... | 82 |
| 5 COMMISSIONING..... | 84 |
| 5.1 Checking Before Power-on..... | 84 |
| 5.2 Powering On..... | 84 |
| 5.3 Setting Common Parameters for the System | 85 |
| 5.4 Checking the Settings..... | 86 |
| 5.5 Powering off..... | 87 |
| 6 SYSTEM OPERATION..... | 88 |
| 6.1 Restarting the System | 88 |

| | | |
|----------|---|------------|
| 6.2 | Viewing the Current System Information | 88 |
| 6.3 | Setting up the System | 89 |
| 6.3.1 | Go to SETUP | 90 |
| 6.3.2 | SYS SETTING | 91 |
| 6.3.3 | BAT SETTING | 99 |
| 6.3.4 | GRID STD..... | 103 |
| 6.3.5 | RUN SETTING | 105 |
| 6.3.6 | RS485 ADDRESS..... | 110 |
| 6.3.7 | BAUD RATE | 110 |
| 6.3.8 | LANGUAGE..... | 110 |
| 6.3.9 | BACK LIGHT | 111 |
| 6.3.10 | DATE/TIME..... | 111 |
| 6.3.11 | CLEAR REC | 111 |
| 6.3.12 | PASSWORD | 111 |
| 6.3.13 | MAINTENANCE..... | 112 |
| 6.3.14 | AUTO TEST..... | 112 |
| 6.3.15 | OPERAT MODE | 113 |
| 6.3.16 | CT SELF CHK | 114 |
| 6.3.17 | AFCI TEST | 114 |
| 6.4 | Viewing INQUIRE | 115 |
| 6.5 | Viewing STATISTIC | 116 |
| 6.6 | Restoring Factory Settings (FCTRY RESET)..... | 116 |
| 6.7 | Operating Battery Packs..... | 117 |
| 6.7.1 | Indicator Lights and States | 117 |
| 6.7.2 | Turning on a Battery Pack | 119 |
| 6.7.3 | Turning off a Battery Pack | 119 |
| 6.7.4 | Resetting a Battery Pack | 119 |
| 6.7.5 | Expanding Battery Capacity | 119 |
| 7 | MAINTENANCE | 120 |
| 7.1 | Inspection Checklist for Users | 120 |
| 7.2 | Inspection Checklist for Professional Personnel | 121 |
| 7.3 | Troubleshooting | 121 |
| 7.3.1 | Error Codes of the System | 122 |
| 7.3.2 | Alarm Codes of the System..... | 125 |
| 7.3.3 | BMS ALARM Warnings..... | 127 |
| 7.3.4 | BMS FAULT Warnings..... | 128 |
| 7.3.5 | BMS PROTECTION Warnings | 130 |
| 8 | STORING AND RECHARGING BATTERIES | 135 |
| 8.1 | Storage Environment Requirements | 135 |
| 8.2 | Interval for Recharging Batteries | 135 |
| 8.3 | Recharging a Battery | 136 |

| | |
|--|------------|
| 9 LIMITED WARRANTY | 139 |
| 9.1 When the Warranty Period Starts and Ends..... | 139 |
| 9.2 What This Warranty Covers..... | 139 |
| 9.3 How to Obtain Warranty Service | 139 |
| 9.4 Customer Responsibility for Warranty Service | 139 |
| 9.5 Limitation of Liability | 140 |
| 10 EMERGENCY PROCEDURE | 141 |
| 10.1 General Handling..... | 141 |
| 10.2 Potential Emergencies..... | 141 |
| 10.2.1 Battery Leakage..... | 141 |
| 10.2.2 Fire or Explosion..... | 142 |
| 10.3 Emergency Handling Plan | 143 |
| 11 DISPOSAL | 144 |
| 12 SPECIFICATIONS..... | 145 |
| 12.1 Hybrid Inverter | 145 |
| 12.2 Battery Terminal Input/Output..... | 146 |
| 12.3 PV Input..... | 146 |
| 12.4 Grid Terminal Input/Output | 147 |
| 12.5 Backup Load Terminal Output | 147 |
| 12.6 Battery Pack (PACK5.1) | 147 |
| 12.7 Parallel Connector Box..... | 148 |
| 13 ABBREVIATIONS | 149 |
| 14 APPENDIX: DEFINITION OF DVC | 151 |

Legal Statement

© Shenzhen KSTAR New Energy Company Limited. 2023. All rights reserved.

All material appearing on this manual (“content”) is the property of Shenzhen KSTAR New Energy Company Limited (“KSTAR New Energy”). Distributing, copying, or forwarding any content to a third party or uploading any content to third-party platforms (such as publicly accessible websites) without prior permission of KSTAR New Energy is expressly prohibited.

Trademarks and Permissions

KSTAR and other KSTAR trademarks used in this manual are owned by Shenzhen KSTAR New Energy Company Limited.

All other trademarks or registered trademarks are the property of their respective owners.

Software License

KSTAR New Energy reserves all rights to the firmware and software. You may not use any of the data in the firmware or software for commercial purposes in any way.

Reverse engineering, decompiling, disassembling, adapting, implanting, or other derivative operations on the equipment are prohibited, as are researching the design and implementation of the equipment, obtaining the source code, infringing on intellectual property rights in any way, and disclosing the results of any performance tests.

Disclaimer

Before transporting, storing, installing, using, and/or maintaining the equipment, read this manual, adhere strictly to its prescriptions, and pay attention to the labels on the equipment.

In this manual,

- “Equipment” refers to the hardware products, firmware, software, components, spare parts, and/or services to which this manual relates.
- “You” or “your” refers to an individual or a legal entity transporting, storing, installing, using, and/or maintaining the equipment.

In addition to paying proper attention to content in this manual labelled DANGER, WARNING, CAUTION, and NOTICE, you shall comply with relevant international, national, or regional standards, and industry practices. KSTAR New Energy shall not be liable for any damages resulting from violations of safety requirements or safety standards for the design, manufacturing, and use of the equipment.

KSTAR New Energy is not responsible for damage, personal injuries, death, and/or loss of or damage to property caused by use outside the scope of the conditions, technical specifications, or instructions provided in this manual.

Transport, storage, installation, use, maintenance, and all other operations shall comply with applicable laws and regulations, standards, and specifications.

KSTAR New Energy shall bear no liability in any of the following circumstances:

- The equipment is damaged due to earthquakes, floods, volcanic eruptions, mudslides, lightning strikes, fires, wars or armed conflicts, typhoons, hurricanes, tornadoes, extreme weather, or other force majeure events.
- The equipment is used outside the scope of the conditions, technical specifications, or instructions provided in this manual.
- Installation and/or use do not comply with relevant international, national, or regional standards or regulations.
- The equipment is installed or operated by unqualified personnel.
- The equipment is operated in a manner not in accordance with the prescriptions of the instruction manual and safety labels.
- The equipment and/or software code is disassembled and/or modified without the permission of KSTAR New Energy.
- The equipment is damaged while being transported by you or a third party commissioned by you.
- The equipment is stored in conditions that do not meet the standards specified in this manual.
- In the course of operating or maintaining the equipment, you use your own materials and tools that do not meet the requirements of local laws, regulations, and standards.
- Damage is caused by you or a third party through negligence, willful misconduct, gross negligence, or mishandling, or for other reasons not attributable to KSTAR New Energy.

1 About This Manual

This manual contains important information on the transport, storage, installation, use, and maintenance of the equipment. Read this manual carefully before operation. You must use the equipment strictly in accordance with the instructions in this manual to prevent damage or loss to the equipment, persons, and/or property. Keep this manual for future reference.

1.1 Purpose

This manual is intended as:

- An introduction to a three-phase hybrid inverter (the E8KT/E10KT/E12KT), and the BluE-PACK-5.1 lithium-ion battery pack.
- An installation and maintenance guide for qualified personnel and technicians working with the hybrid inverters and the battery packs.
- An operating guide for qualified personnel, technicians, and users of the energy management system (EMS) integrated in the hybrid inverter.

This manual does not include information on all the components in a photovoltaic system. For more information, visit www.KSTAR.com or the websites of the component manufacturers.

1.2 Intended Audience

The intended audience of this manual is:

- The qualified professional personnel and technicians who install, operate, and maintain residential photovoltaic energy storage systems that include an E8KT/E10KT/E12KT hybrid inverter, and/or the BluE-PACK-5.1 battery pack.
- Users who need to view inverter parameters.
- System integration solution providers.

1.3 Conventions

The following symbols are used in this manual to highlight important information.



Indicates a hazardous situation that, if not avoided, will result in death or severe injury.



Indicates a hazardous situation that, if not avoided, could result in death or severe injury.



Indicates a hazardous situation that, if not avoided, could result in minor or moderate injury.

NOTICE

Indicates information that is considered important but is not hazard related, typically used for activities that result in property damage, but no personal injury.



Indicates an important tip that leads to the best results, but not safety or damage related.

1.4 Change History

Here is the change history of this manual.

| Version | Date | Changes |
|---------|----------|---|
| 6.1 | Dec-2023 | <ul style="list-style-type: none"> • Added information about BluE-PACK5.1. • Updated Figure 3-6 and its description. • Updated Connecting Battery Packs (BluE-PACK-5.1-16S-100A-F). • Updated EPS ENABLE and PASSWORD. • Updated description of W20 in Alarm Codes of the System. • Updated Recharging a Battery. |
| 6.0 | Dec-2023 | <ul style="list-style-type: none"> • Updated the manual template. |
| 5.0 | Nov-2023 | <ul style="list-style-type: none"> • Updated the spare parts descriptions to make the manual applicable to parallel systems. • Added notes on parallel system settings. |
| 4.0 | Sep-2023 | <ul style="list-style-type: none"> • Modified the descriptions of spare parts. • Added the descriptions of the parallel connector box. |
| 3.0 | Aug-2023 | <ul style="list-style-type: none"> • Added the descriptions of parallel systems. • Optimized some descriptions. |
| 2.0 | Jul-2023 | <ul style="list-style-type: none"> • Modified the descriptions of the LED indicator lights on the battery pack. • Added and refined some descriptions. |
| 1.0 | Nov-2022 | <ul style="list-style-type: none"> • Initial release. |

2 Safety Instructions

All the safety instructions in this section help you transport, store, install, use, and maintain the equipment safely, so be sure to read and follow them. In addition to these safety instructions, you must comply with the requirements of international, national, or regional standards and regulations, and you are encouraged to follow industry best practices.

The equipment must be transported, installed, and maintained by trained professionals who fully understand how the equipment works, have sufficient training and experience in operating the equipment, and know the possible dangers and their levels. Trained personnel are those who have received relevant technical and safety training and have relevant experience. They know the possible dangers they may face when operating the equipment and how to take steps to minimize the dangers to themselves and others.

2.1 Limitation of Liability

KSTAR New Energy is not responsible, directly or indirectly, for any damage to the equipment or loss of property caused by the following:

- Disassembling and/or modifying the equipment, replacing parts, or modifying the software code without the permission of the manufacturer.
- Altering, repairing, and erasing serial numbers or seals by technicians not certified by the manufacturer.
- Installation and/or operation of the equipment by unqualified personnel.
- Installing the inverter in any way that does not comply with standards or regulations.
- Failure to comply with local safety regulations. For example, in Germany, equipment must comply with VDE certification and in Australia it must comply with SAA certification.
- Operation of the equipment in an environment with insufficient ventilation.
- Use not in accordance with the instruction manual, technical specifications, and/or any other instruction provided.
- Use of your own materials and tools that do not meet the requirements of local laws, regulations, and standards.
- Failure to follow standard maintenance procedures.
- Earthquakes, floods, volcanic eruptions, mudslides, lightning strikes, fires, wars, armed conflicts, typhoons, hurricanes, tornadoes, extreme weather, or other force majeure events.

Additionally, KSTAR New Energy is not responsible, directly or indirectly, for:

- Damage sustained during transportation, including paint scratches caused by friction inside the package during transportation, and damage sustained while being transported by you or a third party commissioned by you. You must file claims with the shipping or insurance company when the container and/or the package is unloaded and the damage is confirmed.

- Any other damage caused by you or a third party through negligence, willful misconduct, or mishandling, or for other reasons not attributable to KSTAR New Energy.

2.2 Warning Signs

The warning signs and nameplates attached to the equipment contain important information to guide you in safe use of the equipment. DO NOT remove, obscure, or damage these signs. Make sure that these signs are always intact and fixed in their correct positions. If a warning sign is damaged, contact the manufacturer and have it replaced immediately by certified technicians.

You can see these warning signs attached to the equipment.



Indicates a hazardous situation that, if not avoided, can result in death or severe injury!



Indicates that the inverter should NOT be touched or used for at least five minutes after it is turned off or disconnected, in order to prevent electric shock or personal injury.



Indicates a hot surface. Contact can cause burns.



Indicates that you should read the user manual for instructions.

WARNING

After the equipment is unpacked,

- Check all the warning signs and nameplates on the equipment.
- If you find any damages to the warning signs and/or nameplates on the equipment, contact the manufacturer immediately and DO NOT install the equipment.

WARNING

Before disposal, make sure that all warning signs and nameplates are clearly visible and are not removed or obscured.

WARNING

When you instruct others in use of the equipment, and maintain and/or repair the equipment, follow these instructions to prevent inappropriate use or accidents caused by uninvolved persons:

- Place clear signs at the front and rear-level switches to prevent accidents caused by inappropriate switching.
- Place a warning sign or safety caution tape around the operating area.

2.3 Battery Safety

A rechargeable lithium-ion phosphate battery is used in the equipment. The battery complies with the provisions of “United Nations Recommendations on the Transport of Dangerous Goods, Manual of Tests and Criteria, Part III, Section 38.3”.

KSTAR New Energy shall not be responsible for:

- Damages to the battery caused by earthquakes, floods, volcanic eruptions, mudslides, lightning strikes, fires, wars, armed conflicts, typhoons, hurricanes, tornadoes, extreme weather, or other force majeure events.
- Direct damage caused by operation of the equipment in environments other than the intended operating environment. Indicators of inappropriate environments include, but are not limited to, excessively high or low operating temperatures, instability of the power grid, and frequent power outages.
- Damage, leakage, and/or rupture caused by inappropriate operation or failure to connect the battery pack in accordance with requirements.
- Damage caused by over-discharge of the battery due to the failure of operating personnel to promptly power up the battery after it has been connected to the system.
- Damage caused by your failure to accept the battery in time after installation.
- Damage caused by inappropriate parameters that you set.
- Accelerated battery capacity degradation caused by mixing of batteries, including, but not limited to, the mixing of batteries of different brands and mixing of batteries with different rated capacities.
- Battery damage caused by storing the battery in an unintended environment, such as in a humid, rain-prone environment.
- Loss of capacity or irreversible damage to the battery caused over-storage without recharging the battery in a timely manner.
- Damage caused by your or a third party's failure to follow the requirements specified by the manufacturer, including, but not limited to, unauthorized relocation and installation of the battery packs.

KSTAR New Energy shall not be responsible for damage caused by:

- Frequent over-discharge of batteries caused by your inappropriate maintenance, on-site expansion, or long-term failure to fully charge.
- Lack of appropriate maintenance in accordance with the operating manual. Such battery maintenance should include, but is not limited to, regular checks of the battery terminal screws to verify tightness.
- Changing the battery usage scenario without the approval of the manufacturer.
- Unapproved connection of additional loads to the battery.
- Batteries exceeding the maximum storage life.
- Batteries exceeding the warranty period. Such batteries can pose hazards and it is not recommended that you continue to use them.

2.3.1 General Instructions

The chemical substances inside the battery are well sealed, so there is no physical danger of fire or explosion or chemical danger of hazardous material leakage at normal temperatures and pressure levels during handling. If the battery pack is exposed to fire, mechanical shock, decomposition, or increased electrical stress due to misuse, then leakage, release of harmful substances, and/or explosion can occur. The released substances can irritate the eyes, skin, and throat.



DANGER

- Only trained professionals are permitted to handle leaking batteries.
- When handling leaking batteries, personnel must wear goggles, rubber gloves, gas masks, and protective clothing.
- When handling leaking batteries, personnel must first disconnect the equipment and then remove the leaking batteries.
- Batteries should be protected from the following:
 - Short circuit caused by live line maintenance or by shorting the positive and negative terminals of the battery.
 - Exposure to high temperature or heating equipment, such as direct sunlight, ignition sources, transformers, or heaters.
 - Squeezing by an external force or immersion in water or other liquids.
 - Over-charging or forced over-discharging.
 - Exposing battery terminals to other metal objects.
 - The use of incorrect battery types.



WARNING

Batteries should be protected from the following:

- Malfunctions or short circuits caused by liquid entering the battery. Therefore, DO NOT install the battery pack under air conditioning outlets, ventilation vents, machine room outlet windows, water pipes, and other locations prone to water leakage.
- Inverted, sideways, tilted, or stacked placement.
- False connection of fastening screws of the copper row and/or the cable, which can cause excessive voltage drop or the generation of a large amount of heat at higher current, which could burn the battery.

2.3.2 Maintenance of Battery Packs

 DANGER

- DO NOT perform live line maintenance on the batteries to prevent short circuit.
- Use the specified type of battery during replacement.

 WARNING

- Do a regular check on the fastening screws of copper rows and/or cables. Make sure that they are tightened and free of rust, corrosion, or other foreign objects. If they are not, clean them.
-

2.3.3 Disposal of Battery Packs

 WARNING

- Before disposal, completely discharge the battery and consume the lithium metal inside the battery.
 - DO NOT treat unwanted batteries as ordinary waste.
 - DO NOT throw the battery pack into fire or place them in high temperature.
 - DO NOT dissect, pierce, or crush the batteries.
 - If a battery pack is deformed, broken, or leaking, discard it immediately regardless of how long it has been in storage.
-

2.4 Before Installation



- Follow the safety instructions in this manual to prevent personal injury and/or property damage.
- During transportation, a certified ABC fire extinguisher with a capacity of at least 2 kg must be with the equipment.
- Smoking is not permitted on or near the vehicle while loading or unloading.
- Before installation, make sure that the equipment is free of any electrical connections.
- Make sure that no water pipes are inside the wall on which the system is to be mounted.
- To prevent possible electric shock, make sure that the inverter is not damaged and that the inverter and all switches connected to it are set to the “OFF” position.
- Before installation, use a properly calibrated voltage meter to test the inverter to prevent personal injury or damage caused by a life-threatening voltage.
- The PV string exposed to sunlight can generate high voltage. Do these to prevent personal injury:
 - The operator must wear personal protective equipment before electrical connection.
 - Before touching DC cables, use a measuring device to make sure that the cables are not energized.
 - Read the safety instructions attached to the PV string and its manuals.
 - DO NOT connect the inverter to a PV string that requires positive or negative grounding.

 **WARNING**

- DO NOT transport equipment in severe weather such as lightning, rain, snow, or winds of force 6 or higher.
- If there is a fire, evacuate the building or equipment area and ring the fire alarm. DO NOT enter a burning building or equipment area.
- Choose an appropriate and safe place to install the equipment. This place must meet these requirements:
 - Temperature: For the inverter and battery pack. See [Specifications](#).
 - Relative humidity: 0–95% (No condensation).
 - NO flammable or explosive materials.
 - NOT accessible to children.
 - NO salt hazards.
 - Sheltered from direct sunlight or severe weather.
 - NOT subject to strong vibration or electromagnetic fields.
 - Well ventilated
 - NOT a living area.
- A distance of at least 30 mm must be maintained between the cable and a heat generating device or the periphery of a heat source area to prevent deterioration and/or breakage of the cable insulation caused by high temperature.
- DO NOT install the equipment that is infiltrated by moisture.
- DO NOT install the equipment with damaged enclosure and exposed to moisture.

 **CAUTION**

- Only qualified personnel are permitted to transport the equipment.
- Loading, unloading, installation, removal, and transportation of inverters and battery packs must be accomplished by two or more persons to prevent personal injury caused by accidental falling equipment.
- If lifting tools are used to lift the equipment, make sure that no one passes or stays under the equipment.

NOTICE

- Before installation, do a regular check and maintenance on the tools.

2.5 Installation Safety



- To avoid personal injury caused by the high voltage inside the equipment:
 - Use special insulated tools for wiring.
 - Read the warning signs on the equipment and follow their instructions.
 - Follow the safety instructions in this manual and other documents provided.
 - Only trained professionals are permitted to install the equipment.
 - Only qualified personnel are permitted to disassemble the safety features and to service the equipment.
 - Only the personnel who have the special operation qualification required by national or local authorities are permitted to work in special scenarios such as electrical operation, work at heights, and operation of special equipment.
 - Only KSTAR-approved professional personnel are permitted to replace the equipment or spare parts (including software).
 - DO NOT power up the equipment before the installation is completed and confirmed by trained professionals.
 - Avoid direct contact with the power supply equipment, as well as indirect contact through wet objects. Prevent other conductors from coming into contact with the power supply equipment. Measure the voltage at the point of contact before you touch any conductor surface or terminal, so as to avoid electric shock.
 - Use appropriate measuring tools to make sure that the electrical parameters of the equipment meet the requirements. To prevent electric arcs or shocks, make sure that the connection and use of the equipment comply with the specifications.
-

 **WARNING**

- DO NOT install equipment in severe weather such as lightning, rain, snow, or winds of force 6 or higher.
- If there is a fire, evacuate the building or equipment area and ring the fire alarm, or call the emergency services. DO NOT enter a burning building or equipment area.
- It is recommended that you install the inverter vertically, not inverted, horizontal, tilted forward or backward, excessively tilted, or tilted sideways.
- When tightening screws or bolts on products or terminals with tools, tighten to the specified torque to prevent damage to the equipment. The manufacturer shall not be responsible for such damage.
- DO NOT touch the equipment surface when the equipment is in operation. The housing gets hot, and touching it can result in burns.
- The cables used in the PV system must be of the right size, firmly connected, and well insulated.
- Before connecting the DC connector to the inverter, check the positive and negative terminals of the PV string and make sure that no error occurs before inserting the DC connector into the DC terminal.
- During the installation of the inverter, make sure that neither the positive nor the negative terminal of the PV string is shorted to ground, to prevent damage caused by AC/DC short circuit of the inverter.

 **CAUTION**

- To prevent uninvolved persons from approaching the equipment, place highly visible warning signs or set up safety caution tape around the equipment.
- DO NOT remove the equipment protection.
- DO NOT ignore the danger, warning, caution, and notice text in the manuals and on the equipment.

NOTICE

- The wiring process must follow the regulations of the local grid and the safety instructions for the PV string.

2.6 Operation Safety

DANGER

- Follow the safety instructions in this manual to prevent personal injury and/or property damage.
- The person who operates the equipment must have necessary knowledge of the equipment, including the equipment components and how they work.
- The person who operates the equipment must have necessary knowledge of this manual.
- Only qualified personnel are permitted to disassemble the safety features and to service the equipment.
- Keep persons other than those operating the equipment away from the equipment.
- DO NOT operate the equipment in an environment where explosions can occur, or where the relative humidity is high.
- When the equipment is in operation,
 - DO NOT open the inverter and the battery packs.
 - DO NOT wipe the equipment with a wet cloth.
 - DO NOT touch the housing of the equipment.
 - DO NOT plug or unplug connectors on the inverter.
 - To avoid electric shock, DO NOT touch any terminals of the inverter.
 - To avoid electric shock, DO NOT disassemble any parts of the inverter.
 - To avoid burns, DO NOT touch any hot parts of the inverter, such as radiator.
 - To avoid electric shock, DO NOT connect or disconnect a PV string or a component of a PV string.
- To avoid fatal electric shock, DO NOT touch the DC conductors or energized electrical parts of the inverter. When PV arrays are exposed to sunlight, they can generate life-threatening DC voltage. This voltage can be present in DC conductors and in the energized electrical parts of the inverter.
- To avoid electric shocks and burns caused by possible arcs, DO NOT disconnect the DC connector from the inverter under load.
- Before operating the inverter or the battery packs, disconnect the inverter from all voltage sources as described in this manual.
- DO NOT touch uninsulated cable ends.

-
- To prevent chemical burns caused by leakage of electrolyte or toxic gases from a damaged battery, operate the battery packs in accordance with the standard procedure. When the battery packs are operated in a standard manner, no leakage of electrolyte or generation of toxic gases can occur. However, if the battery packs are damaged or malfunction, it can leak electrolyte or generate toxic gases.

 WARNING

- DO NOT operate equipment in severe weather such as lightning, rain, snow, or winds of force 6 or higher.
- DO NOT touch the equipment with wet hands.
- DO NOT put any heavy objects on the top of the equipment.
- DO NOT damage the equipment with sharp objects.

 CAUTION

- To prevent uninvolved persons from approaching the equipment, place highly visible warning signs or set up safety caution tape around the equipment.
- DO NOT move the inverter when it is connected to the battery packs.
- Secure the inverter to prevent tilting.
- During the operation of the equipment, if any risks are found that may lead to personal injury or equipment damage, stop the operation immediately, report to the person in charge, and take effective steps.
- During the operation of the inverter, make sure that neither the positive nor the negative terminal of the PV string is shorted to ground, to prevent damage caused by AC/DC short circuit of the inverter.

NOTICE

- In the event of exposure to the electrolyte, immediately flush the affected area with water and seek immediate medical attention.
-

2.7 Maintenance Safety

 DANGER

- Follow the safety instructions in this manual to prevent personal injury and/or property damage.
- Only trained professionals are permitted to maintain the equipment.
- Only qualified personnel are permitted to disassemble the safety features and to service the equipment.
- Keep persons other than those operating the equipment away from the equipment.
- Wear personal protective equipment (PPE), including protective gloves and protective shoes.
- DO NOT begin maintenance work on the equipment until it is turned off and fully discharged.
- Before maintenance, disconnect the AC circuit breaker from the grid and check the inverter status. If all the inverter indicator lights are off, do nothing and disconnect the DC switch at night. If the inverter indicator is on, disconnect the DC switch directly.
- After the inverter is powered down for five minutes, use testing equipment to check the voltage of the bus capacitor and of the capacitors in the battery terminal input and make sure that there is no voltage.
- To avoid burns, DO NOT operate the equipment immediately after shutdown. After the equipment cools down, wear protective gloves to operate the equipment.

 WARNING

- DO NOT maintain equipment in severe weather such as lightning, rain, snow, or winds of force 6 or higher.
- To avoid electric shock, DO NOT touch the power grid or the contacts and terminals inside the equipment that are connected to the grid.
- Use a standard voltmeter to check the grid. DO NOT touch the grid before you make sure that there is not voltage.
- To prevent or to minimize potential damage caused by moisture, DO NOT repair or maintain the equipment in a wet environment.

 CAUTION

- To prevent uninvolved persons from approaching the equipment, place highly visible warning signs or set up safety caution tape around the equipment.
-

NOTICE

- If the paint on the inverter housing falls off or rust appears, repair it in a timely manner. Otherwise, the use of the inverter may be affected.
 - To avoid damaging the inverter, DO NOT use cleaning agents to clean the inverter. The manufacturer shall not be responsible for such damages.
 - DO NOT open the inverter (excluding the cable box) and replace the components inside without the permission of the manufacturer.
-

2.8 Disposal Safety

 DANGER

- Only trained professionals are permitted to discard the equipment.
-

 WARNING

- Before disposal, make sure that all warning signs and nameplates are clearly visible and have not been removed or obscured.
 - To prevent property damage and personal injury, dispose of equipment in accordance with local regulations and standards.
-

3 Product Introduction

3.1 Features

The E8KT/E10KT/E12KT is a residential photovoltaic storage system that is composed of a power control module and an extendable battery pack. It stores and releases electrical energy according to the inverter management system requirements. KSTAR New Energy provides a photovoltaic storage-monitoring platform to monitor and control electricity generation and storage of the E8KT/E10KT/E12KT. Power generation, consumption, and storage can be grasped at any time and any place, and the information can be monitored and controlled remotely. The E8KT/E10KT/E12KT comes with an integrated energy management system (EMS). This system enables the inverter to run off-grid or on-grid and manages energy flow intelligently so that the system can operate economically.

3.2 Delivery Scope

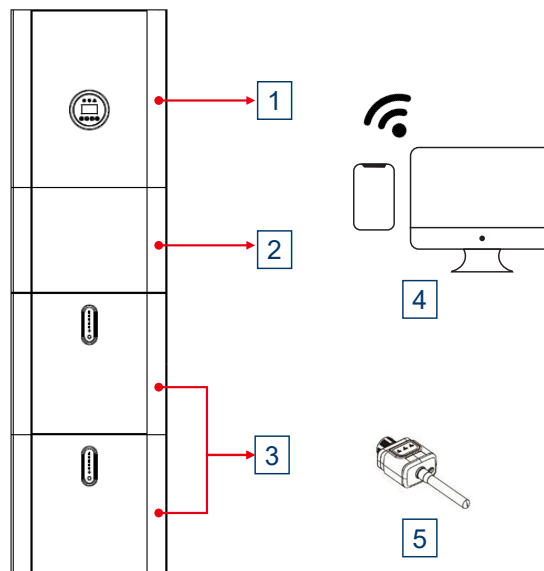

Figure 3-1 E8KT/E10KT/E12KT Delivery Scope

- 1** Hybrid inverter (with integrated Energy Management System).
- 2** Cable box, connected to the inverter, for cable connection.
- 3** Battery packs (PACK5.1), extendable.
- 4** SOLARMAN, for remote monitoring, available in a web-based portal and an APP. For more information, see *Stick Logger Quick Guide*.
- 5** Stick logger, to be connected to the inverter. For more information, see *Stick Logger Quick Guide*.

3.3 Model

3.3.1 Inverter Model

The hybrid inverter model is E8KT/E10KT/E12KT.

$$\frac{\text{E}}{\boxed{1}} \quad \frac{\text{xK}}{\boxed{2}} \quad \frac{\text{T}}{\boxed{3}}$$

- 1 “E” means “energy storage system”.
- 2 “xK” indicates the rated output of the system. “8K” means 8 kW, “10K” means 10 kW, and “12K” means 12 kW.
- 3 “T” means “three-phase inverter”.

3.3.2 Battery Pack Model

Two battery pack models are available for the E8KT, E10KT, or E12KT.

For BluE-PACK-5.1-16S-100A-F

One is BluE-PACK-5.1-16S-100A-F.

$$\frac{\text{BluE-PACK-5.1-16S-100A-F}}{\boxed{1} \quad \boxed{2} \quad \boxed{3} \quad \boxed{4} \quad \boxed{5} \quad \boxed{6}}$$

- 1 “BluE” means the name of the product series.
- 2 “PACK” means the label “PACK”.
- 3 “5.1” means the battery capacity is 5.1 kWh.
- 4 “16S” means the battery pack is combined by 16 battery cells in series.
- 5 “100A” means the rated current is 100 A.
- 6 “F” means with a heating film. If it is “N”, it means without a heating film.

For BluE-PACK5.1

The other model is BluE-PACK5.1.

$$\frac{\text{BluE-PACK5.1}}{\boxed{1} \quad \boxed{2}}$$

- 1 “BluE” means the name of the product series.
- 2 “PACK” means the label “PACK” and “5.1” means the battery capacity is 5.1 kWh.

3.4 Inverter Appearance

Here is the appearance of the inverter with the uncovered cable box. You can use the integrated EMS on the LCD screen to set up the system.

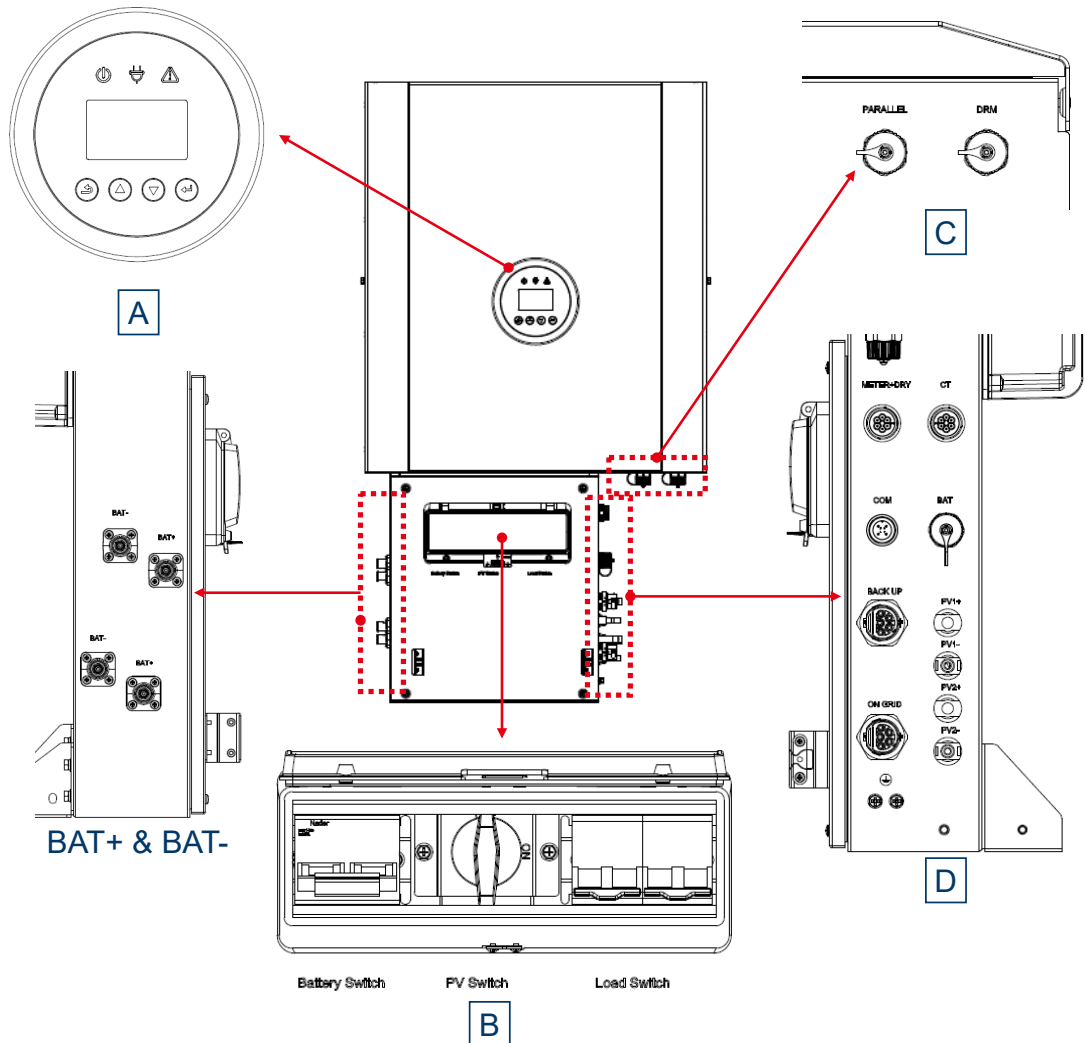

Figure 3-2 Inverter, Cable Box (No Cover), LCD Screen, and Ports

3.4.1 LCD Screen

You can use the LCD screen (A) on the inverter to operate the integrated EMS.

- ⏻ Indicator light. When this indicator light is on, the inverter is connected to the grid. When this indicator light is blinking and the other indicator lights are off, the inverter is running and grid power is bypassed.
- ⏚ Indicator light. When this indicator light is on, the inverter runs off-grid.
- ⚠ Indicator light. This indicator light turns on (red) when a fault has occurred.
- ↻ Button. On the home page, press this button to go to the USER page to change the settings. You can press this button to leave the current page.

- ▲
 Button. Press this button to move the cursor up or to increase the setting value.
- ▼
 Button. Press this button to move the cursor down or to decrease the setting value.
- ↵
 Button. Press this button to confirm the selection. When the LCD screen shows the current system information in turn automatically, you can press this button to lock the screen to show one page of information.

3.4.2 Switches

In [Figure 3-3](#), B shows the switches inside the cable box. The switches are protected by a cover.

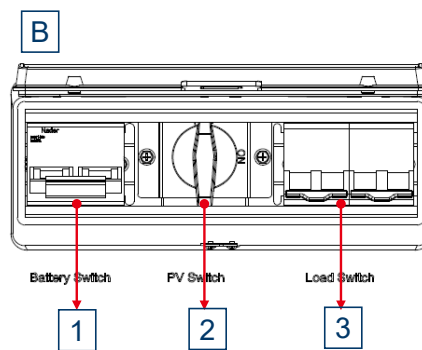

Figure 3-3 Switches in the Cable Box

- 1 Battery Switch
- 3 PV Switch
- 2 Load Switch

3.4.3 Ports

In [Figure 3-4](#), C shows the ports on the bottom side of the inverter.

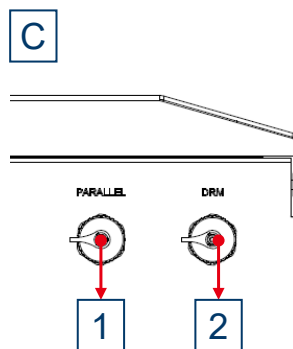

Figure 3-4 Inverter Ports

- 1 PARALLEL (DVC A)
- 2 DRM (DVC A)

In [Figure 3-5](#), D shows the ports on the right side of the cable box.

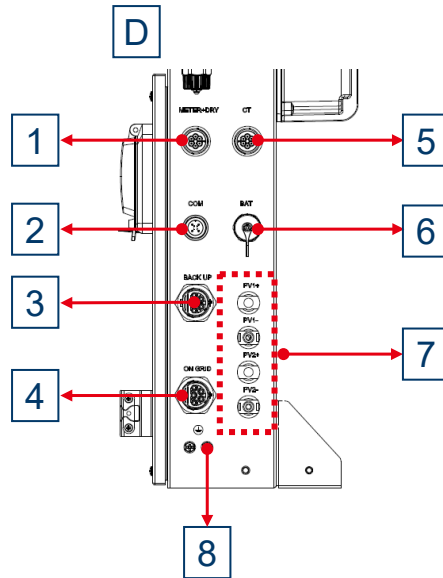

Figure 3-5 Cable Box Ports

- | | |
|------------------------------|--------------------------|
| 1 METER + DRY (DVC A) | 2 COM (DVC A) |
| 3 BACK UP (DVC C) | 4 ON GRID (DVC C) |
| 5 CT (DVC A) | 6 BAT (DVC A) |
| 7 PV1, PV2 (DVC C) | 8 PE (DVC A) |



Decisive voltage classification (DVC) identifies the minimum necessary level of protection for the circuit. For more information on the DVC of each port, see [Appendix: Definition of DVC](#).

3.5 Battery Pack Appearance

BluE-PACK-5.1-16S-100A-F

Figure 3-6 shows the appearance of the BluE-PACK-5.1-16S-100A-F.

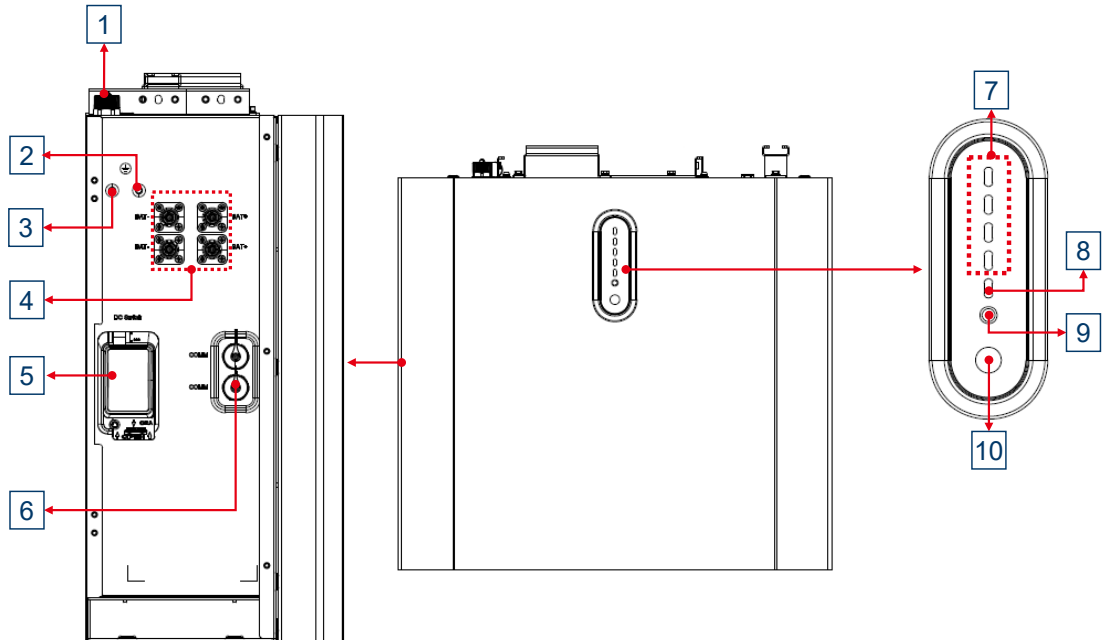

Figure 3-6 Appearance of BluE-PACK-5.1-16S-100A-F

- 1 INV. Used for communication between the inverter and the battery pack.
- 2 PE1 3 PE2 4 BAT+ and BAT- 5 DC Switch
- 6 COMM. Supports RS485 communication only.
- 7 COMM. Supports RS485 and RS232 communications. You can use this port to connect the battery pack and the upper computer and thus view the background data of the battery pack.
- 8 The SOC indicator lights, composed of four indicator lights, work in conjunction with the **FAULT** light and the **OPERATION** light to show the states of the battery pack. For more information, see [Indicator Lights and States](#) of battery packs.
- 9 The **FAULT** indicator light works in conjunction with the SOC lights and the **OPERATION** light to show the states of the battery pack. For more information, see [Indicator Lights and States](#) of battery packs.
- 10 The **OPERATION** indicator light works in conjunction with the SOC lights and the **FAULT** light to show the states of the battery pack. For more information, see [Indicator Lights and States](#) of battery packs.
- 11 Button. Press the button to turn on, turn off, and reset the battery pack. For more information, see [Turning on a Battery Pack](#), [Turning off a Battery Pack](#), and [Resetting a Battery Pack](#).

BluE-PACK5.1

Figure 3-7 shows the appearance of the BluE-PACK5.1.

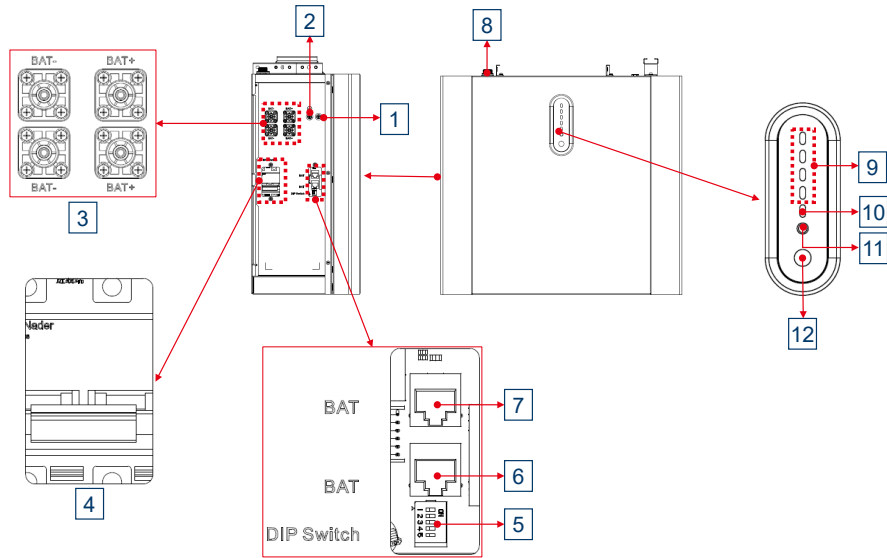

Figure 3-7 Appearance of BluE-PACK5.1

- 1** PE1 **2** PE2 **3** BAT+ and BAT- **4** Battery Switch
- 5** DIP Switch. Turn the DIP switches numbered 1, 2, 3, and 4 to the ON or OFF position to assign the address to the battery pack.



The DIP switch numbered 5 connects or disconnects the terminating resistor of the CAN bus. ON connects the resistor to the bus circuit and OFF disconnects the resistor. This switch is set to OFF by default. Under typical usage of the system, the state of this switch has no effect of operation of the system, but it is not recommended that you change the setting of this switch. If the communication of the battery pack CAN bus fails, you can turn this switch to ON to troubleshoot the problem.

Table 3-1 DIP Switch Settings of BluE-PACK5.1

| Address | DIP Switch 1 | DIP Switch 2 | DIP Switch 3 | DIP Switch 4 |
|---------|--------------|--------------|--------------|--------------|
| 1 | ON | OFF | OFF | OFF |
| 2 | OFF | ON | OFF | OFF |
| 3 | ON | ON | OFF | OFF |
| 4 | OFF | OFF | ON | OFF |
| 5 | ON | OFF | ON | OFF |
| 6 | OFF | ON | ON | OFF |
| 7 | ON | ON | ON | OFF |
| 8 | OFF | OFF | OFF | ON |

- 6 BAT. Supports RS485 and RS232 communications. You can use this port to connect the battery pack and the upper computer and thus view the background data of the battery pack.
- 7 BAT. Supports RS485 communication only.
- 8 INV. Used for communication between the inverter and the battery pack.
- 9 The SOC indicator lights, composed of four indicator lights, work in conjunction with the **FAULT** light and the **OPERATION** light to show the states of the battery pack. For more information, see [Indicator Lights and States](#) of battery packs.
- 10 The **FAULT** indicator light works in conjunction with the SOC lights and the **OPERATION** light to show the states of the battery pack. For more information, see [Indicator Lights and States](#) of battery packs.
- 11 The **OPERATION** indicator light works in conjunction with the SOC lights and the **FAULT** light to show the states of the battery pack. For more information, see [Indicator Lights and States](#) of battery packs.
- 12 Button. Press the button to turn on, turn off, and reset the battery pack. For more information, see [Turning on a Battery Pack](#), [Turning off a Battery Pack](#), and [Resetting a Battery Pack](#).

3.6 Energy Management System (EMS)

The inverter incorporates an electric energy management system (EMS) for low-voltage power distribution systems. It is an extended development of the energy management system that complies with the standard specifications of the power distribution system. It is highly automated, easy-to-use, high-performance, and highly reliable. You can use this system on the LCD screen on the inverter to deploy loads, optimize operation, and effectively save power.

3.7 Parallel System

With the E8KT/E10KT/E12KT, you can connect up to four inverters of the same model in parallel to build a parallel system. In a parallel system, loads must be connected in parallel on both the on-grid and backup sides. Compared with a system installed with one inverter, a parallel system expands the system capacity. For example, the rated power of the on-grid side of a system installed with one E10KT is 10 kW, but the rated power of the on-grid side of a parallel system with three E10KTs is 30 kW ($= 3 \times 10 \text{ kW}$). The rated power of the backup side is calculated in the same way.

To build a parallel system, you must set one inverter as the primary inverter, and others as subordinate inverters. For more information, see [Installing a Parallel System](#).



- In a parallel system, the LCD screen on each inverter shows the total grid power and total normal load power of the system.
- In a parallel system, for some settings, such as working mode, zero export, and time setting of the PEAK SHIFT mode, you only need to set them in the primary inverter. These settings in the subordinate inverters are to be forced to synchronize with the primary inverter, but the setting values shown on the LCD screens of the subordinate inverters do not automatically change in synchronization.
- In a parallel system, all settings must be the same for all inverters except for the addresses of the inverters.

3.8 Scenarios

The E8KT/E10KT/E12KT can be used in both a DC-coupling system and an AC-coupling system.

3.8.1 DC-coupling System

In a DC-coupling system, the DC electricity generated by the PV panels is directly sent to and stored in the batteries through the inverter. A DC-coupling system is ideal for a new on- and off-grid solar+storage system installation.

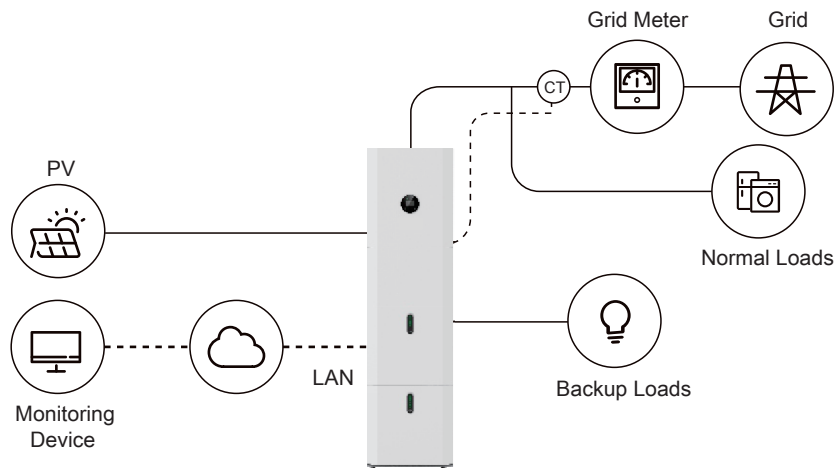

Figure 3-8 DC-coupling System

Here is the single line diagram of a DC-coupling system.

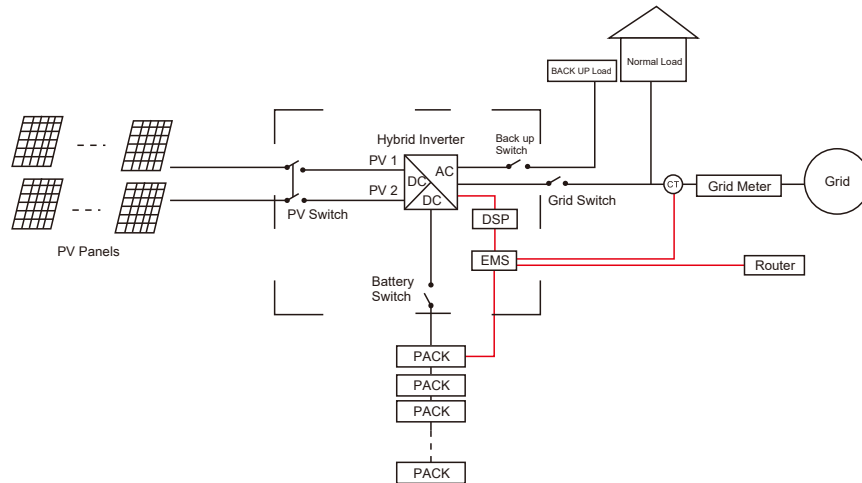

Figure 3-9 Single Line Diagram, DC-coupling System

3.8.2 AC-coupling System

In an AC-coupling system, DC electricity flows from PV panels to the inverter, the AC electricity from the inverter flows to the household loads or other inverters to transform the AC electricity back to DC electricity, and then store it in the batteries. An AC-coupling system is ideal for retrofit.

The E8KT/E10KT/E12KT supports two AC-coupling system schemas.

If you already have a PV inverter and now want to add an energy storage system to the inverter, but no PV panel is available for connection, you can use AC-coupling system Schema 1.

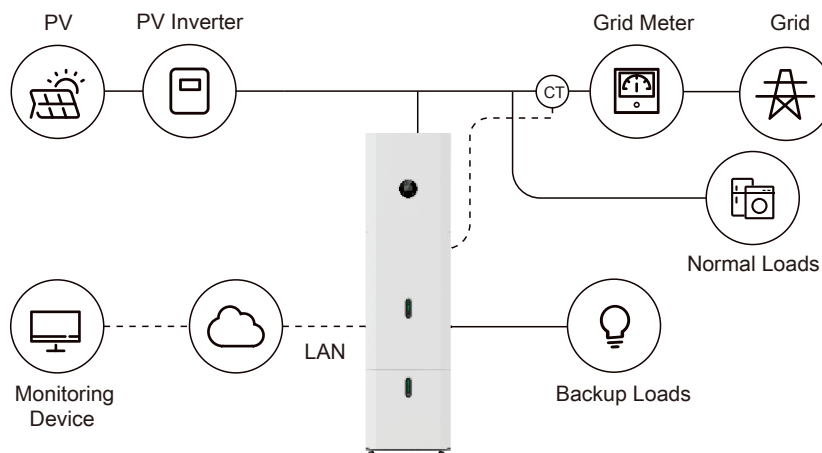

Figure 3-10 AC-coupling System, Schema 1

Here is the single line diagram of an AC-coupling system Schema 1.

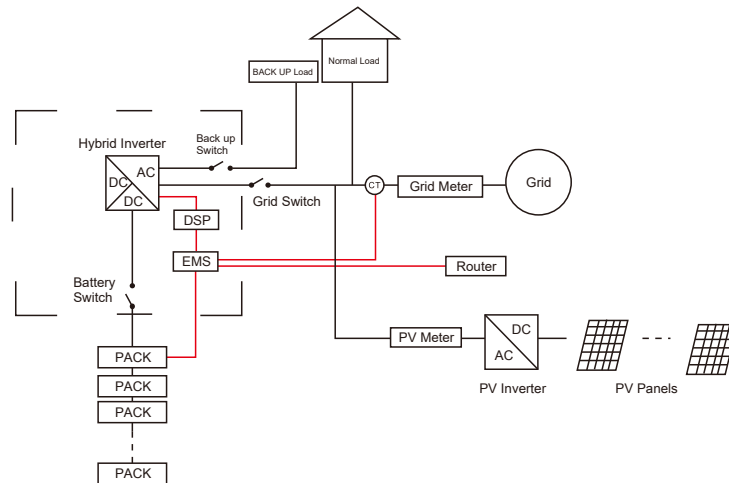

Figure 3-11 Single Line Diagram, AC-coupling System Schema 1

If you already have a PV inverter, now want to add an energy storage system to the inverter, and a PV panel is available for connection, you can use Schema 2 of AC-coupling system.

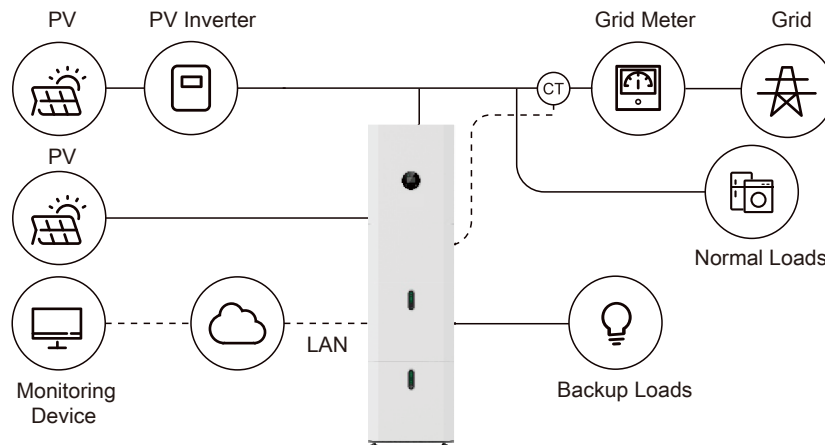

Figure 3-12 AC-coupling System, Schema 2

Here is the single line diagram of an AC-coupling system Schema 2.

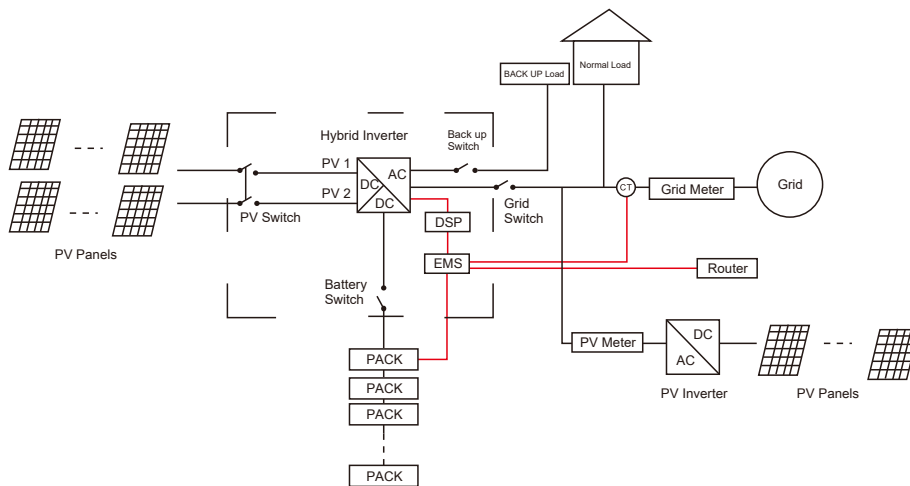

Figure 3-13 Single Line Diagram, AC-coupling System Schema 2

3.9 Wiring Diagram

NOTICE

Make sure that the grounding resistance is less than 10 Ω.

In Australia, New Zealand, and South Africa, direct connection of the N cable and the PE cable in the distribution box is necessary, as shown in [Figure 3-14](#).

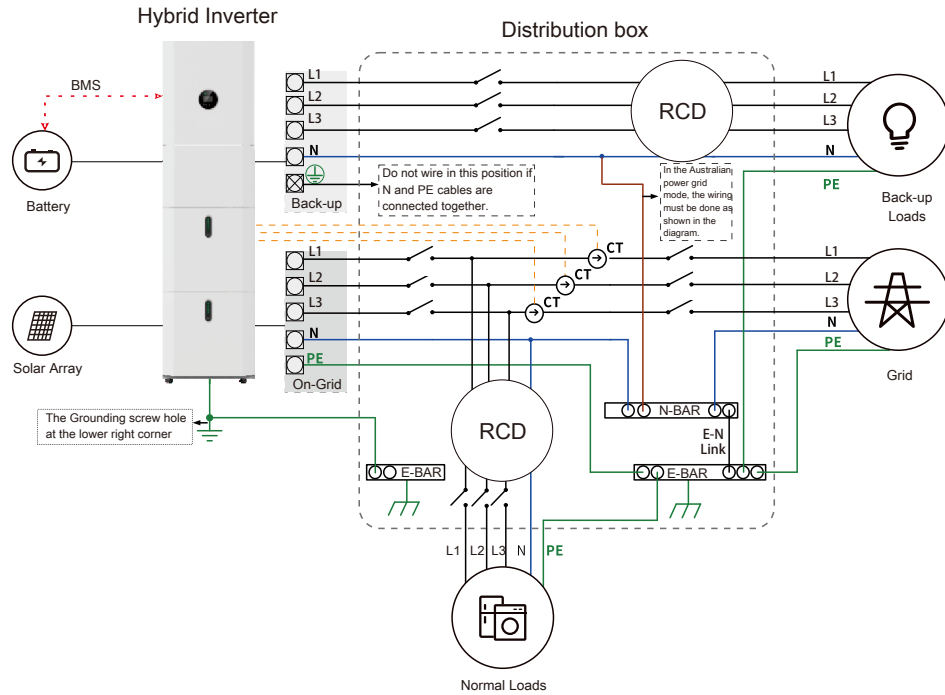

Figure 3-14 Wiring for Australia, New Zealand, and South Africa

Outside Australia, New Zealand, and South Africa, the N cable and the PE cable in the distribution box must be wired separately, as shown in [Figure 3-15](#).

Make sure that the grounding of the backup load is correct and tightened. Otherwise, during a grid failure, the backup may not function normally.

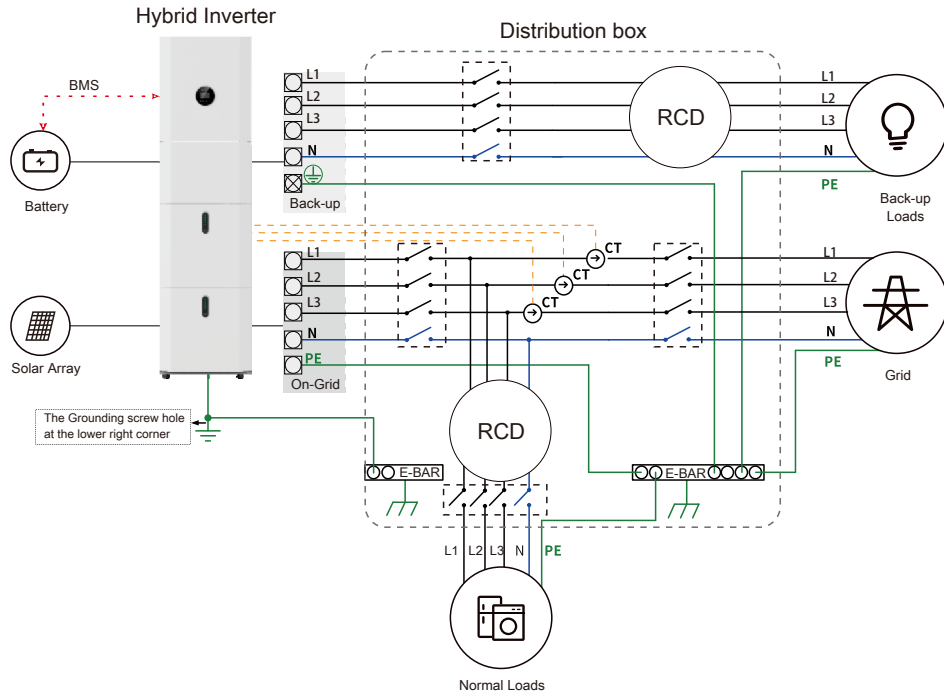

Figure 3-15 Wiring Outside Australia, New Zealand, and South Africa

3.10 System States

3.10.1 Inverter States

The inverter can be in four states shown in [Table 3-2](#).

Table 3-2 Inverter States

| State | Description |
|-----------------|---|
| RUNNING | Generally, when the inverter is powered on, the inverter is in the RUNNING state. When the inverter is connected to the grid, the light on the LCD screen is on. When the inverter is not connected to the grid, the light on the LCD screen is on. |
| IDLE | When the LCD screen is ON but all the indicator lights are off, the inverter is in the IDLE state. |
| FAULT | When an error code is shown, the inverter is in the FAULT state and the light turns on. When the error code is cleared, the light turns off and the inverter returns to the RUNNING or IDLE state. |
| SHUTDOWN | When the inverter is powered off, it is in the SHUTDOWN state. All indicator lights on the LCD screen are off. |



For more information about the error codes, see [Error Codes of the System](#) and [Alarm Codes of the System](#).

3.10.2 Battery Pack States

A battery pack can be in five states: OFF, NORMAL, ALARM, FAULT, and PROTECTION. For more information, see [Indicator Lights and States](#).

3.11 Working Modes

The E8KT/E10KT/E12KT supports three working modes: SELF CONSUME, BAT PRIORITY, and PEAK SHIFT. You can choose a working mode through the integrated EMS. For more information, see the [WORK MODE](#) subsection under [SYS SETTING](#).

3.11.1 SELF CONSUME

In SELF CONSUME mode, the electricity generated by the PV panels is consumed in this order:

Step 1. Supplies electricity for household use.

Step 2. Stores the excess electricity in batteries.

Step 3. Pushes the excess electricity onto the local power grid.

When the sun goes down, the household power supply is automatically switched to the batteries. If the power supply from the batteries is not sufficient, power is sourced from the local power grid.

3.11.2 BAT PRIORITY

In BAT PRIORITY mode, the batteries are only used as backup. When the grid fails, the household load is powered by the batteries. When the grid is working, the household load is powered by the grid, not by the batteries. The PV panels or the local power grid send electricity to the batteries, where it is stored until needed.

3.11.3 PEAK SHIFT

In PEAK SHIFT mode, you can determine the charging and discharging time of the battery yourself. You can set the time through the integrated EMS. For more information, see the [WORK MODE](#) subsection under [SYS SETTING](#).

4 Installation

With the E8KT/E10KT/E12KT, you can install a PV energy storage system using either of two schemas:

- Install one hybrid inverter and two, four, six, or eight battery packs.
- Install a parallel system with multiple hybrid inverters of the same model, each with its own battery packs, connected in parallel. For more information, see [Installing a Parallel System](#).

Follow the steps in [Figure 4-1](#) to install a PV energy storage system with an E8KT/E10KT/E12KT.

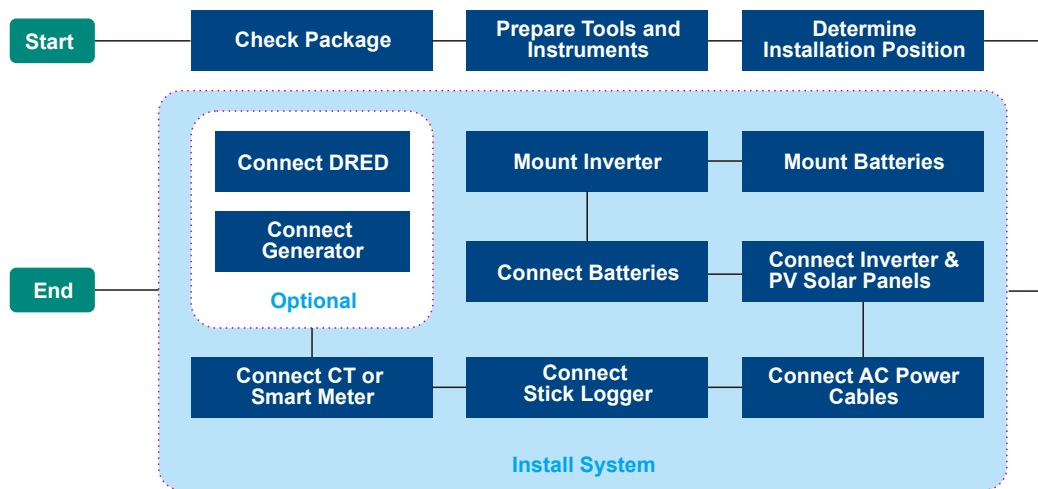

Figure 4-1 Installation Procedure

⚠ DANGER

Only trained professionals are permitted to install the system.
Three trained professionals are necessary to carry out installation.







4.1 Checking the Package

Open the package, make an inventory of its contents, and make sure that all hybrid inverter and battery pack components are present.

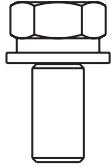
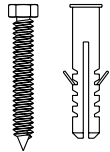
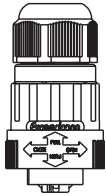
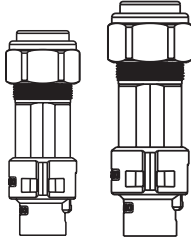
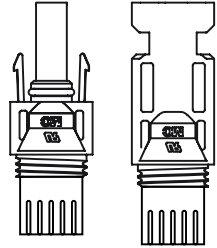
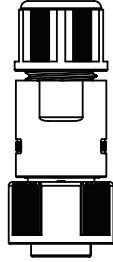
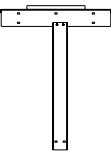
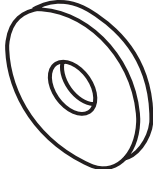
⚠ WARNING

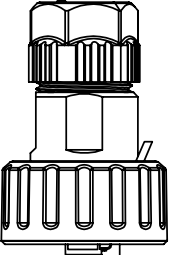

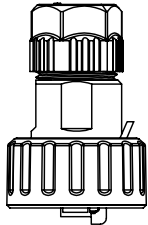
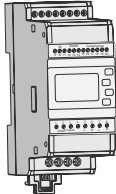
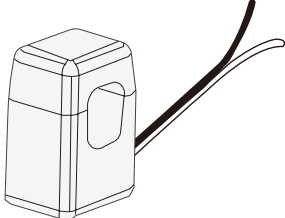
Before opening the package, make sure that the box is not damaged.

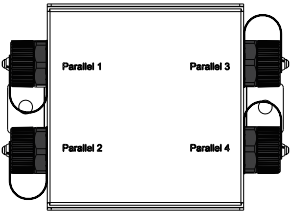
4.1.1 Hybrid Inverter Components

| | | |
|---|--|--|
|  <p>6 × M5*12</p> |  <p>5 × ST6.3*50 5 × D10*50</p> |  <p>2 × CT&Meter Connector</p> |
|  <p>2 × AC Connector</p> |  <p>4 × MC4</p> |  <p>1 × COM Connector</p> |
|  <p>1 × Mounting Panel</p> |  <p>5 × M6 Gasket</p> |  <p>1 × Stick Logger</p> |
|  <p>1 × DRM Connector</p> |  <p>1 × User Manual</p> |  <p>1 × Parallel Connector (Optional)</p> |
|  <p>1 × Smart Meter (Optional)</p> |  <p>3 × CT (Optional)</p> |  <p>1 × Meter Communication Cable (5 m, Optional)</p> |
|  <p>1 × Parallel Connector Box Package (Optional, for more information, see Installing a Parallel System.)</p> | | |

4.1.2 Battery Pack Components

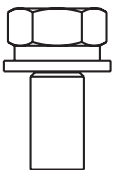
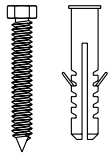
A minimum of two battery packs are necessary for an E8KT/E10KT/E12KT energy storage system. A battery pack delivery includes the following.

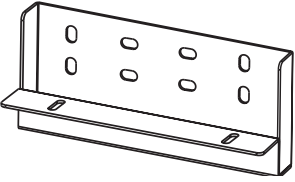
| | | |
|---|--|--|
|  <p>2 × M5*12</p> |  <p>4 × ST6.3*50 4 × D10*50</p> |  <p>4 × M6 Gasket</p> |
|  <p>1 × Mounting Kit</p> | | |

You can order a floor stand support for installation. For an E8KT/E10KT/E12KT energy storage system with four, six, or eight battery packs, battery top covers are necessary. The quantity of battery top covers and floor stand supports is determined by the number of battery packs.

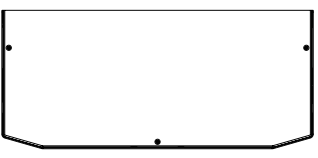
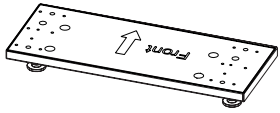
| | |
|--|--|
|  <p>Battery Top Cover</p> |  <p>Floor Stand Support (Optional)</p> |
|--|--|

4.1.3 Cables

Here are the cables necessary for connections. The specifications and quantity of cables depends on the number of battery packs ordered.

Table 4-1 Cables for BluE-PACK-5.1-16S-100A-F



| Cable | | Quantity | | | |
|-------|---------|----------------|----------------|----------------|----------------|
| | | 2 × PACK5.1 | 4 × PACK5.1 | 6 × PACK5.1 | 8 × PACK5.1 |
| PE | 520 mm | 1 | 2 | 3 | 5 |
| | 1000 mm | 1 | 1 | 1 | 1 |
| | 2000 mm | 0 | 1 | 2 | 2 |
| COM | 585 mm | 1 | 2 | 3 | 5 |
| | 600 mm | 1 | 1 | 1 | 1 |
| | 2600 mm | 0 | 1 | 2 | 2 |

| | | | | | |
|-------------------------|---------|---|---|---|---|
| BAT- (black) | 260 mm | 1 | 1 | 1 | 1 |
| | 490 mm | 0 | 2 | 2 | 4 |
| | 850 mm | 1 | 0 | 1 | 1 |
| | 1600 mm | 0 | 1 | 0 | 0 |
| | 2600 mm | 0 | 0 | 2 | 2 |
| BAT+ (red) | 260 mm | 1 | 0 | 0 | 0 |
| | 490 mm | 0 | 2 | 2 | 4 |
| | 850 mm | 1 | 0 | 0 | 0 |
| | 1100 mm | 0 | 1 | 0 | 0 |
| | 1600 mm | 0 | 0 | 1 | 0 |
| | 2600 mm | 0 | 1 | 3 | 2 |
| | 3500 mm | 0 | 0 | 0 | 2 |

Table 4-2 Cables for BluE-PACK5.1

| Cable | | Quantity | | | |
|-------------------------|---------|------------------------|------------------------|------------------------|------------------------|
| | | 2 × PACK5.1 | 4 × PACK5.1 | 6 × PACK5.1 | 8 × PACK5.1 |
| PE | 520 mm | 1 | 2 | 3 | 5 |
| | 1000 mm | 1 | 1 | 1 | 1 |
| | 2000 mm | 0 | 1 | 2 | 2 |
| COM | 600 mm | 1 | 1 | 1 | 1 |
| | 750 mm | 1 | 2 | 3 | 5 |
| | 3000 mm | 0 | 1 | 2 | 2 |
| BAT- (black) | 260 mm | 1 | 1 | 1 | 1 |
| | 490 mm | 0 | 2 | 2 | 4 |
| | 850 mm | 1 | 0 | 1 | 1 |
| | 1600 mm | 0 | 1 | 0 | 0 |
| | 2600 mm | 0 | 0 | 2 | 2 |
| BAT+ (red) | 260 mm | 1 | 0 | 0 | 0 |
| | 490 mm | 0 | 2 | 2 | 4 |
| | 850 mm | 1 | 0 | 0 | 0 |
| | 1100 mm | 0 | 1 | 0 | 0 |
| | 1600 mm | 0 | 0 | 1 | 0 |
| | 2600 mm | 0 | 1 | 3 | 2 |
| | 3500 mm | 0 | 0 | 0 | 2 |

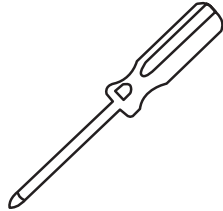
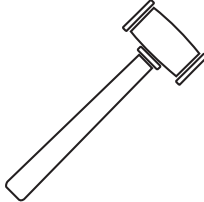
4.2 Preparing Tools and Instruments

| | | |
|---|---|---|
|  |  |  |
| Protective Goggles | Protective Gloves | Protective Mask |
|  |  |  |
| Protective Shoes | Wire Clamp | Cable Crimper |
|  |  |  |
| φ10mm Power Drill | Flat-head Screwdriver | Torque Wrench |
|  |  |  |
| Cross Screwdriver | Multi-meter | Rubber Mallet |
|  |  |  |
| Leveling Instrument | Tape Measure | Marker Pen |
|  |  |  |
| Wire Stripper | ON GRID Wire (10 AWG or 6 mm ²) | BACKUP Wire (12 AWG or 4 mm ² ,) |
|  | | |
| PV Wire (12 AWG or 4 mm ² , max. Voltage 1,000 V) | | |

4.3 Installation Position Requirements

The E8KT/E10KT/E12KT energy storage system can be installed indoors or outdoors, but the position for installation must meet these requirements:

- Sufficient space for personnel to install and maintain the equipment and to operate the LCD screen on the hybrid inverter and the control panels of the battery packs.
- Ambient temperature: For the inverter and battery pack. See [Specifications](#).
- Relative humidity: 0–95% (No condensation).
- Level floor, but not sloped.
- Sheltered from direct sunlight or severe weather.
- Well ventilated
- NOT near flammable or explosive materials.
- NOT exposed to salt hazards.
- NOT subject to strong vibration or electromagnetic fields.
- NOT a habitable room, as defined in AS/NZS 3000
- NOT accessible to children.

4.3.1 Restrictions

DO NOT install the system in these locations:

- Habitable rooms, as defined in AS/NZS 3000
- A ceiling or wall with a cavity
- On a roof
- Entrance or exit
- Underneath staircases or passageways
- Areas where relative humidity and condensation exceed 95%
- Places exposed to salty air
- Earthquake zones, unless additional safety measures have been taken
- Places at more than 2,000 meters above sea level
- Places in direct sunlight or places where the ambient temperature varies a lot
- Places with flammable materials and gases
- Places where explosions may occur
- Locations where the installation of panels is restricted by AS/NZS 3000
- Within 600 mm of any heat source, for example, hot water unit, gas heater, air conditioning unit, or any other equipment
- Within 600 mm of any outlet
- Within 600 mm of any window or vent
- Within 600 mm of the side of any other installation
- Hazardous areas with insufficient distance from gas cylinders or gas relief valves as defined in AS/NZS 3000

When the E8KT/E10KT/E12KT is installed indoors, make sure that the building structure, room furniture, and appliances do not interfere with the operation and maintenance of the system.

If the E8KT/E10KT/E12KT is installed in a corridor, aisle, lobby, or similar area that leads to an emergency exit, at least one meter of space must be allowed for safe egress.

To prevent fire, the wall or structural surface on which the E8KT/E10KT/E12KT is mounted must be made of non-combustible material. If the wall or structural surface is not made of non-combustible material, a layer of non-combustible material can be placed between the equipment and the surface.

4.3.2 Clearance Requirements

If the E8KT/E10KT/E12KT is mounted on a wall or on a surface that is 300 mm from a wall or structure that separates the equipment from habitable rooms, the distance between the equipment and other structures or objects must be increased. The minimum required clearance is as follows:

- 600 mm to the sides of the equipment
- 500 mm above the equipment
- 600 mm in front of the equipment

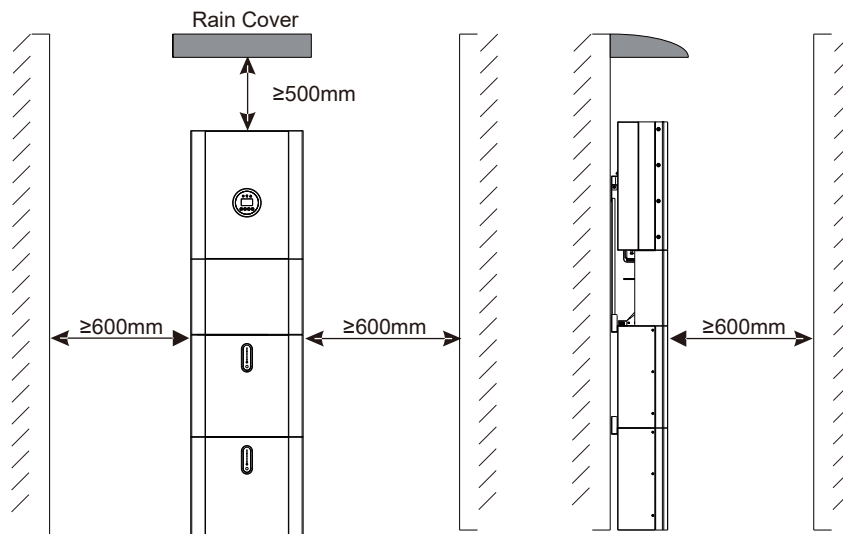

Figure 4-2 Peripheral Clearance Requirements for Installation

NOTICE

- For outdoor installations, a shelter above the equipment is necessary.
- When installing the E8KT/E10KT/E12KT, make sure that the distance between the highest point of the equipment and the ground or the mounting platform does not exceed 2.2 meters.

If the distance between the E8KT/E10KT/E12KT and the object above it, for example, a ceiling, is less than 500 mm, the surface of the object must be paved with non-combustible material in the form of a circle with a radius of 600 mm around the center of the equipment.



The minimum distance between the E8KT/E10KT/E12KT and the object above it must be more than 200 mm.

4.4 Installing the System

Follow the steps in this section to install an E8KT/E10KT/E12KT energy storage system with one hybrid inverter.

4.4.1 Mounting Battery Packs

Move the battery pack from the packaging box and mount it on the wall.

NOTES

- The battery pack should be moved by three persons. One battery pack weighs more than 50 kg.
- Wear protective goggles and mask to prevent the dust created during drilling from entering the respiratory tract and eyes.
- Move the battery pack horizontally.

PROCEDURE

- Step 1.** If you ordered a floor stand support, use a flat screwdriver and a wrench to fasten the footpads to the floor stand support. Put the floor stand support in the orientation marked "Front" on the support. Use a leveling instrument to make sure that the floor stand support is level.

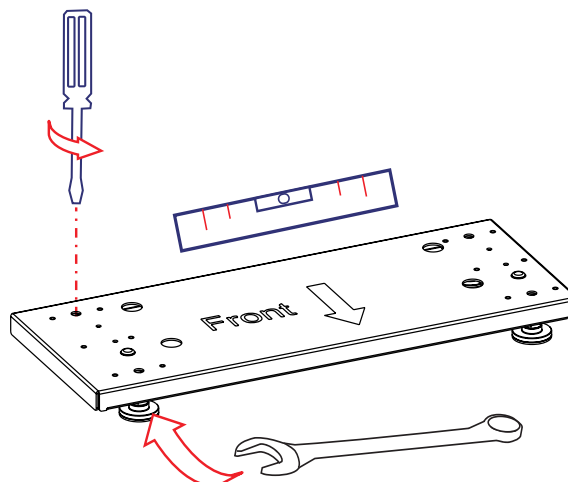

Step 2. Align the first battery pack with the wall. Use a leveling instrument to make sure it is level.

If a floor stand support is used, align it with the wall, make sure it is 3–5 cm away from the wall, and then put the first battery pack on it. Use the stamped bumps on the floor stand support to align the first battery pack.

⚠ WARNING

Make sure that the wall surface for mounting the battery pack is stable.

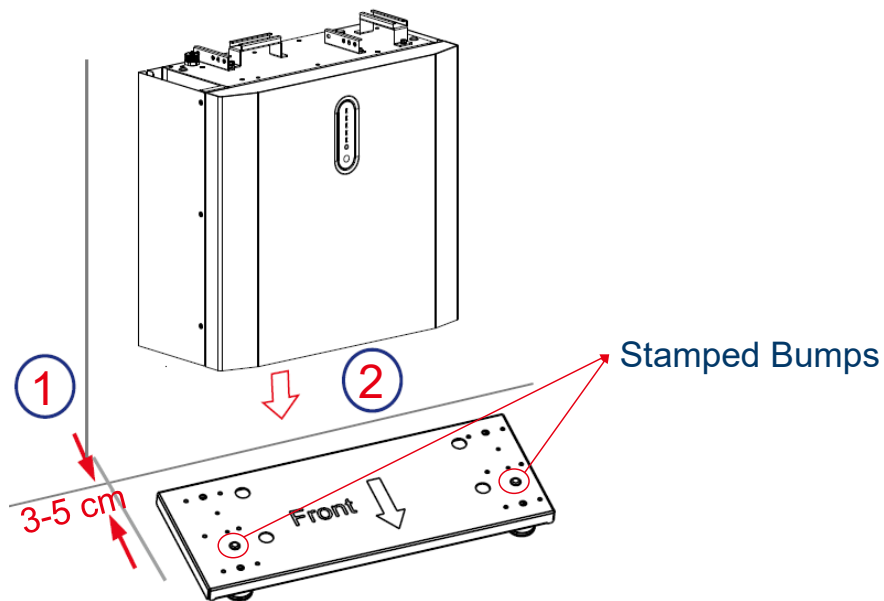

Step 3. Put the mounting kit on the battery, align it with the wall, identify the four locations where the holes will be drilled and mark them with a marker.

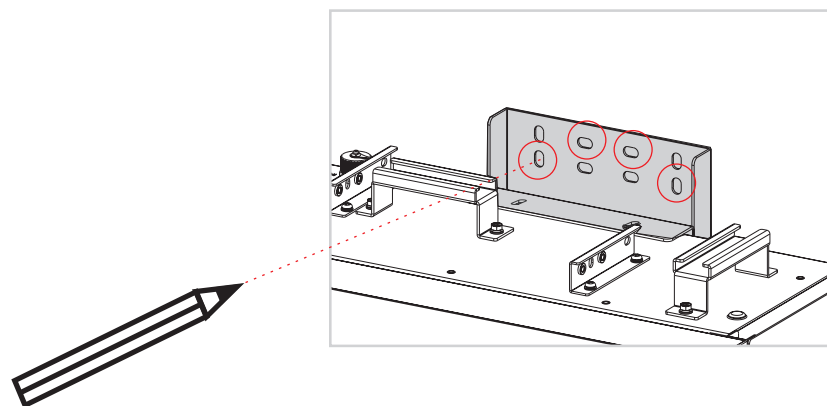

⚠ DANGER

To avoid potential dangers, make sure that no water pipes are inside the wall on which the battery pack is to be mounted.

- Step 4.** Use a power drill to drill the holes. The diameter of the hole is approximately 10 mm, and the depth is approximately 70 mm.
- Step 5.** Use a rubber mallet to drive ST6.3*50 into the holes, and then use the gaskets and the D10*50 expansion screws to fix the mounting kit to the wall.

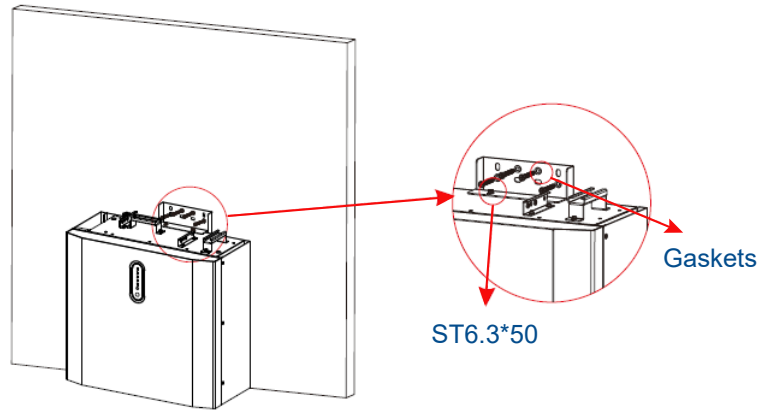

- Step 6.** Use the M5*12 screws to secure the mounting kit to the first battery pack.

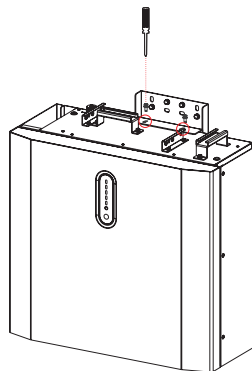

- Step 7.** Align the two battery packs, using the stamped bumps on the top of the first battery pack.



Before you put a battery pack on top of another one, make sure that the max inclination of the wall is 1.5%.

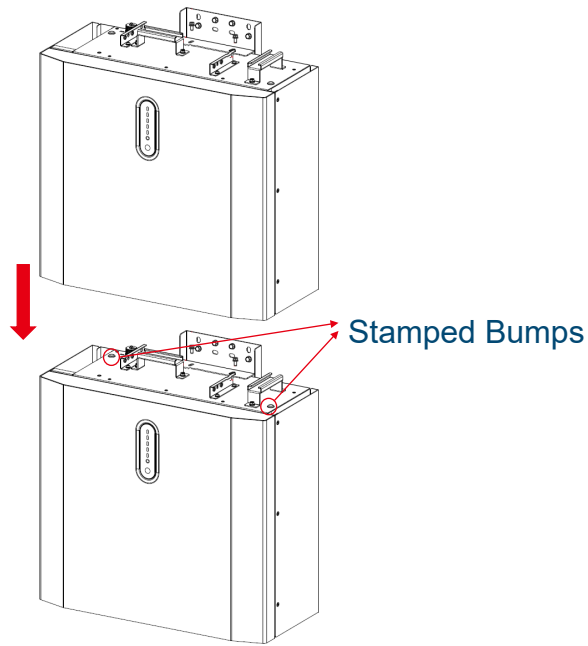

Step 8. Stack the mounting panel in front of the mounting kit, identify the four locations where the holes will be drilled, and then mark them with a marker.

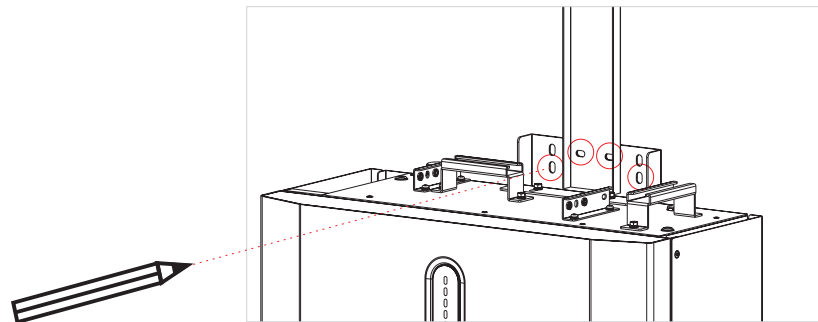

Step 9. Identify the locations of the five holes for fixing the mounting panel to the wall and mark them with a marker.

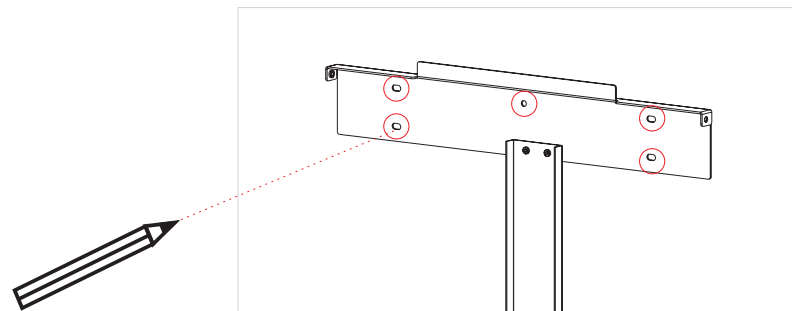

NOTICE
Make sure that the mounting panel and the battery pack are perpendicular to each other.

- Step 10.** Use a power drill to drill the holes. The diameter of the holes is approximately 10 mm, and the depth is approximately 70 mm.
- Step 11.** Use the rubber mallet to drive ST6.3*50 into the holes, use the gaskets and the D10*50 expansion screws to fix the mounting kit together with the mounting panel to the wall, and then use the M5*12 screws to secure the mounting kit to the second battery pack.
- Step 12.** Use the rubber mallet to drive ST6.3*50 into the holes, and use the gaskets and the D10*50 expansion screws to fix the mounting panel to the wall.

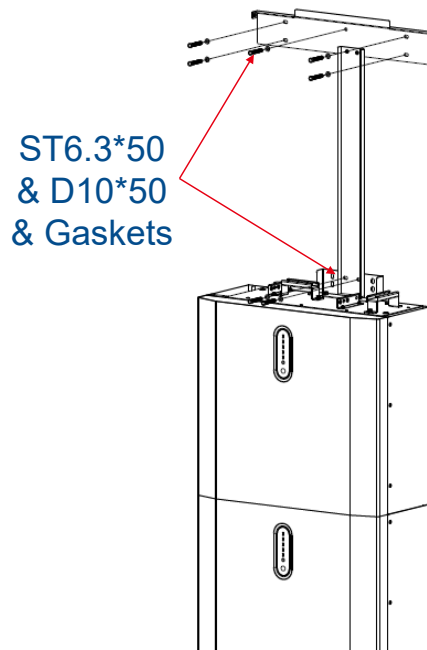

- Step 13.** If you want to mount four, six, or eight battery packs, mount and stack the battery packs as shown in these figures.

⚠ CAUTION

The distance between two stacks of battery packs must be 300–400 mm.

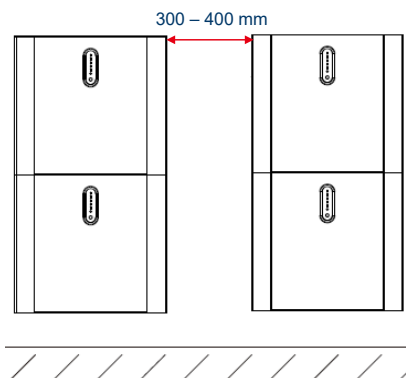

Figure 4-3 Mounting Four Battery Packs

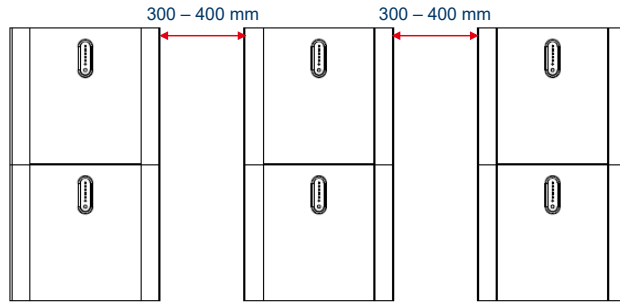

Figure 4-4 Mounting Six Battery Packs

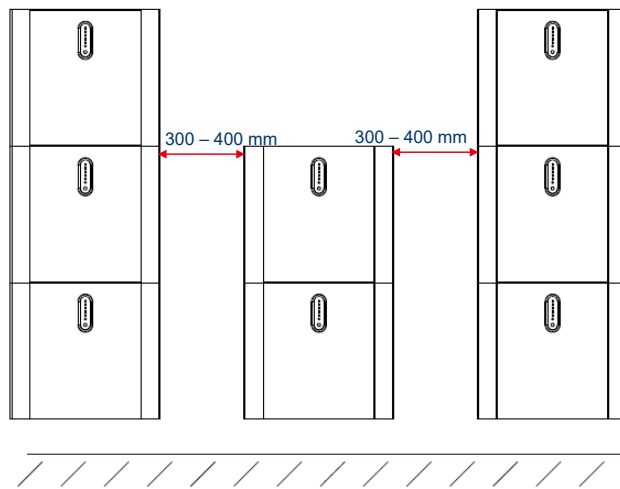

Figure 4-5 Mounting Eight Battery Packs

4.4.2 Mounting the Inverter

NOTES

The inverter should be moved by three persons. One inverter weighs approximately 50 kg.

Wear protective goggles and a mask to prevent the dust created during drilling from entering the respiratory tract or eyes.

PROCEDURE

Step 1. Hook up the inverter to the mounting panel and use the M5*12 screws to secure the inverter to the top battery pack and the mounting panel.

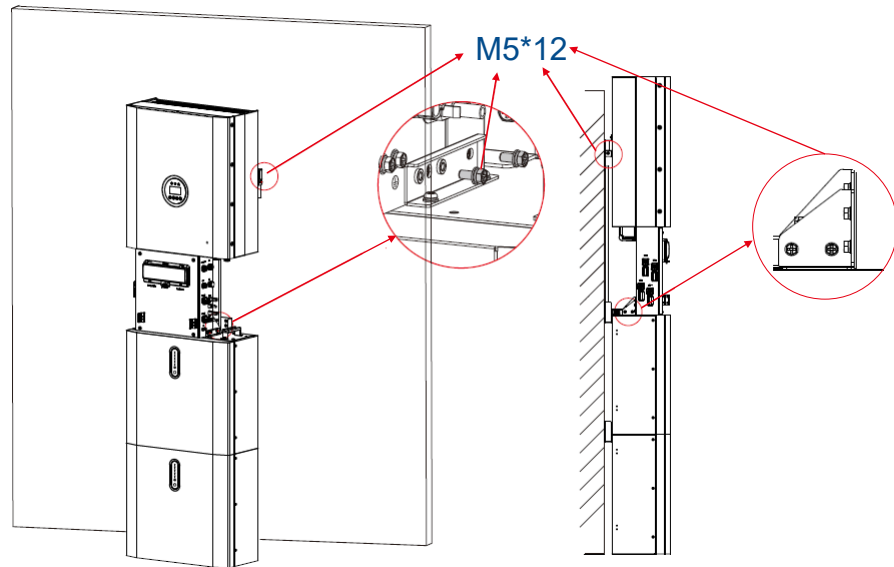

Step 2. If four, six, or eight battery packs were mounted, follow Step 1 to mount the inverter on the stack of battery packs as shown in these figures.

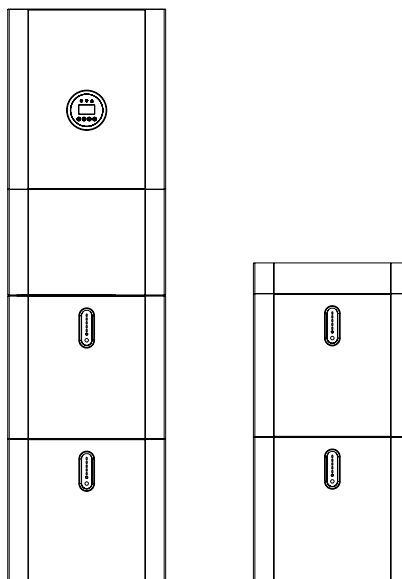

Figure 4-6 Mount an Inverter for Four Battery Packs

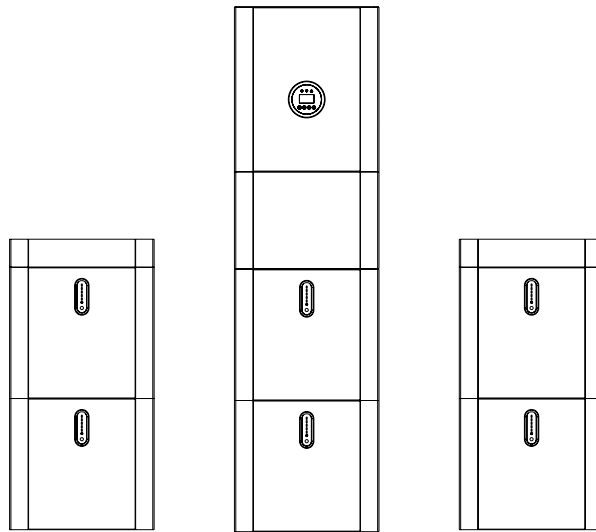

Figure 4-7 Mount an Inverter for Six Battery Packs

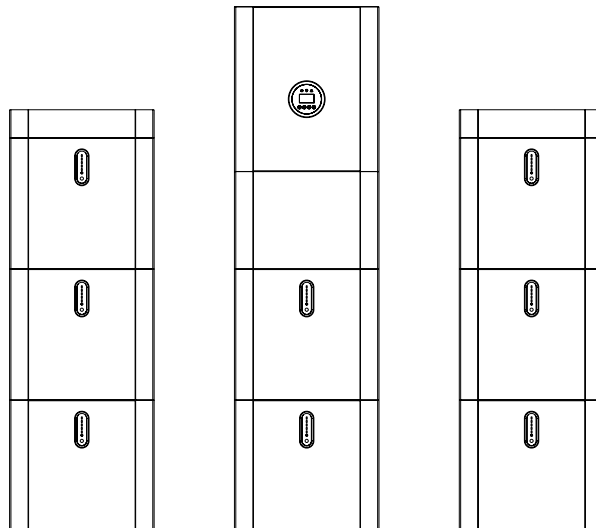

Figure 4-8 Mount an Inverter for Eight Battery Packs

4.4.3 Connecting Battery Packs (BluE-PACK-5.1-16S-100A-F)

NOTES

- Before connection, make sure that the voltages of the batteries are correct.
- Make sure that both the Battery Switch inside the cable box and the DC Switch inside the side cover of a battery pack are in the OFF state. For more information, see [Switches](#) of the inverter.

PROCEDURE

Step 1. On the battery packs, remove the screws on the side covers and open the covers.

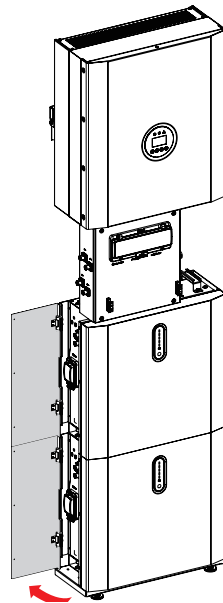

Step 2. Remove the screws from the PE port inside the cable box and the PE1 port on the side of the top battery pack. Use the 1000 mm PE cable (G-1000) to connect the ports and then replace the screws.

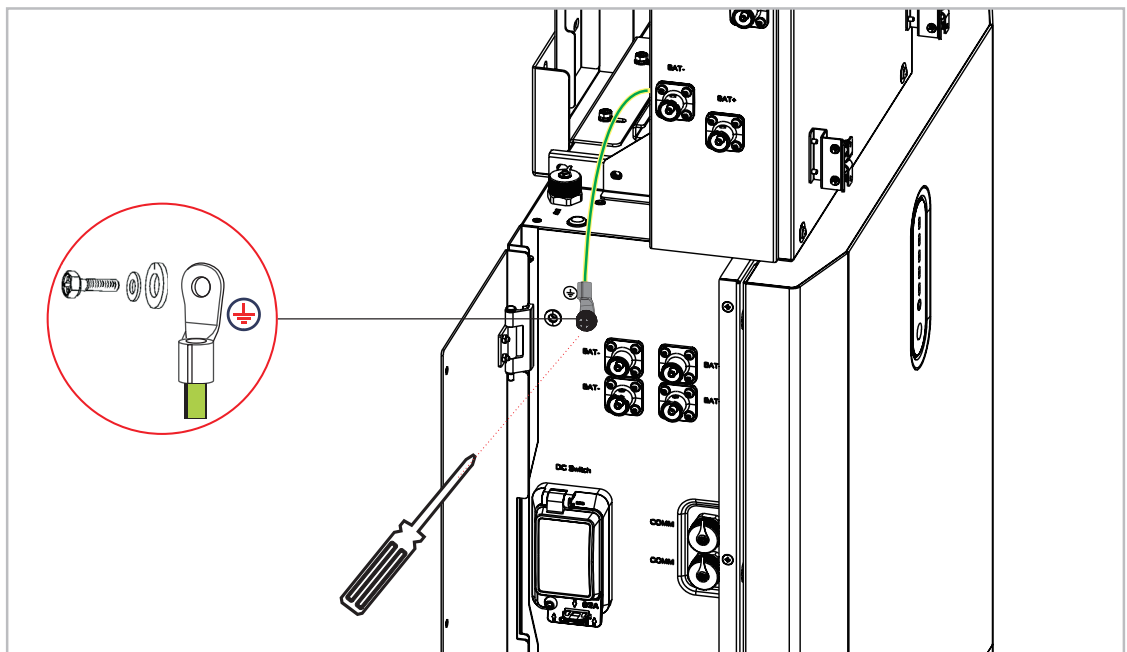

Step 3. Use the 260 mm BAT cables (DR-260 and DB-260) to connect the BAT+ and BAT- ports inside the cable box and on the side of the second battery. Use the 850 mm BAT cables (DR-850 and DB-850) to connect the BAT+ and BAT- ports inside the cable box and on the side of the first battery.

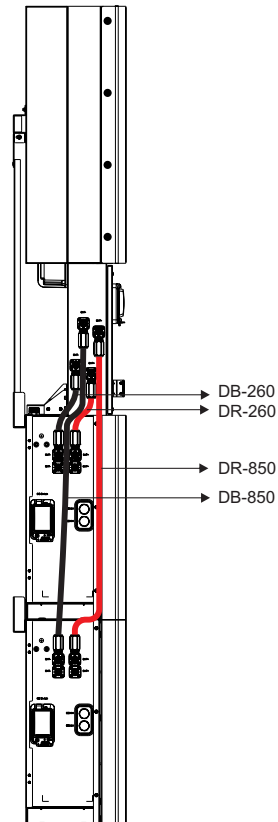

Step 4. Follow this diagram to make the connections:

- Use the 600 mm COM cable (C-600) to connect the BAT port inside the cable box and the INV port on the battery pack.
- Use the 585 mm COM cable (C-585) to connect the lower COMM port of the second battery pack and the upper COMM port of the first battery pack.
- Remove the screws from the PE ports of the battery packs, use a 520 mm PE cable (G-520) to connect the PE2 ports, and then replace the screws.

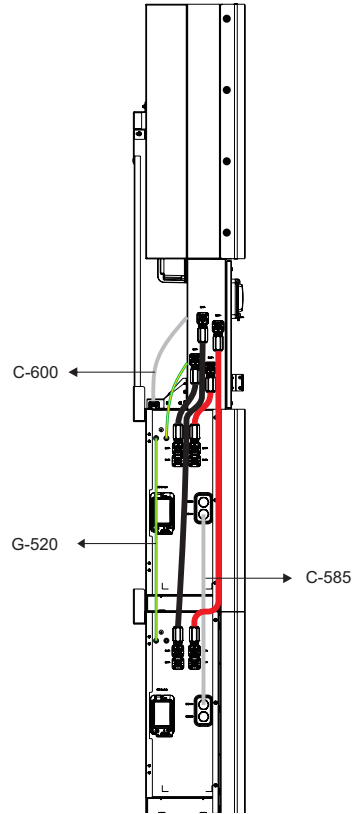

Step 5. If you mounted four, six, or eight battery packs, connect them as shown in these diagrams.

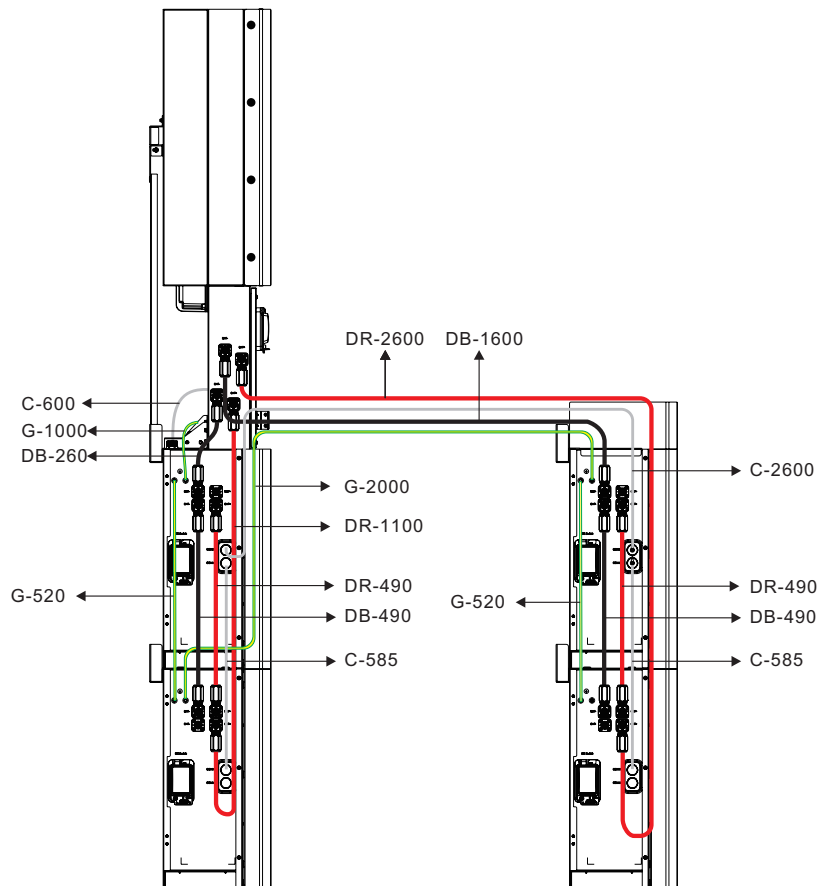

Figure 4-9 Connect Four BluE-PACK-5.1-16S-100A-F

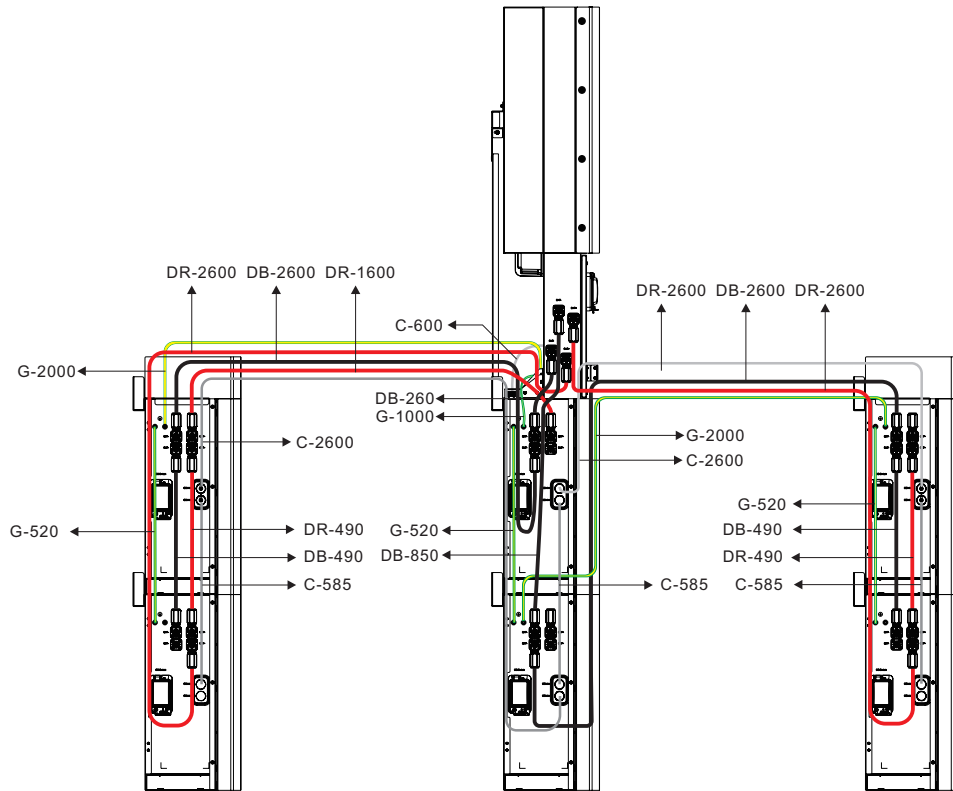

Figure 4-10 Connect Six BluE-PACK-5.1-16S-100A-F

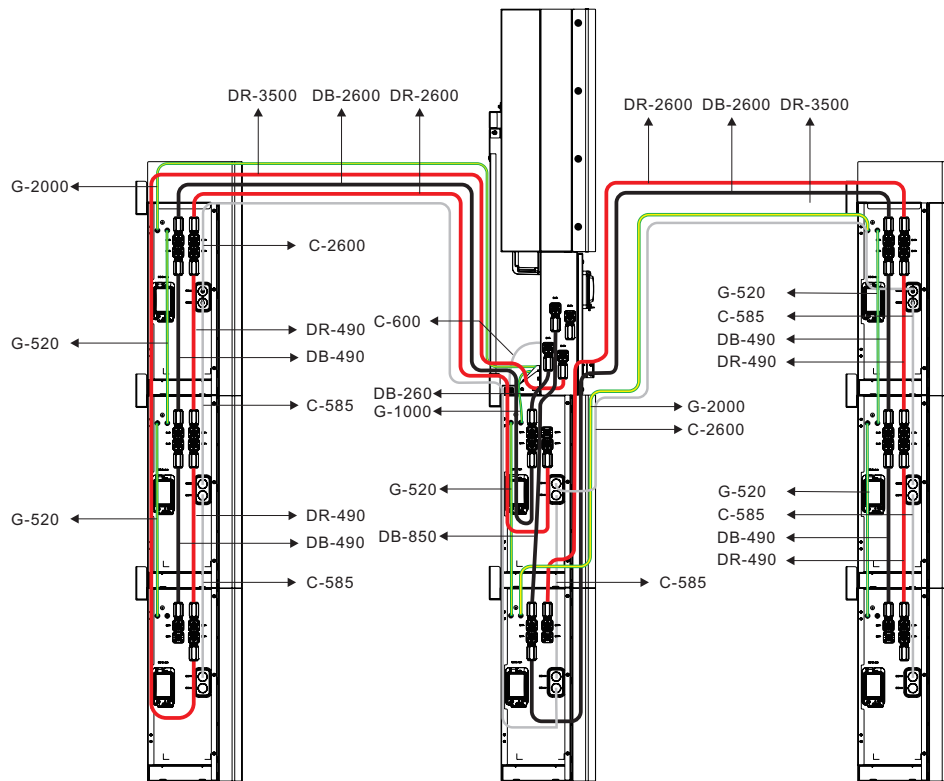

Figure 4-11 Connect Eight BluE-PACK-5.1-16S-100A-F

- Step 6.** Close the side covers of all the battery packs and replace the screws.
- Step 7.** Put the top covers on the battery packs and tighten the screws as shown in these figures.

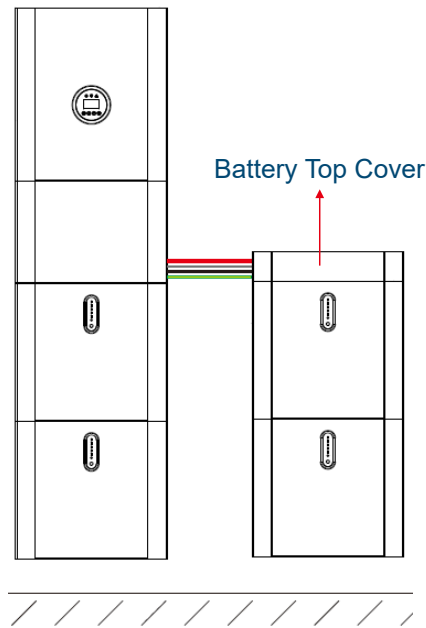

Figure 4-12 A System with Four BluE-PACK-5.1-16S-100A-F (With Top Covers)

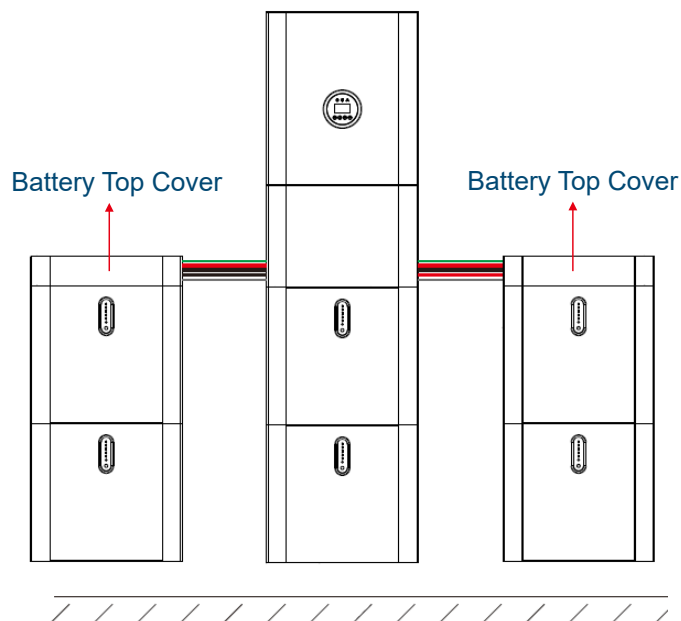

Figure 4-13 A System with Six BluE-PACK-5.1-16S-100A-F (With Top Covers)

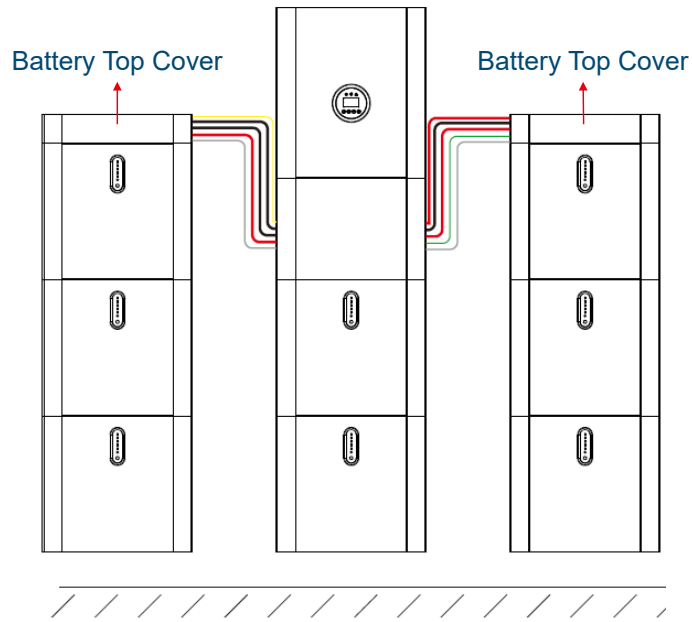

Figure 4-14 A System with Eight BluE-PACK-5.1-16S-100A-F (With Top Covers)

4.4.4 Connecting Battery Packs (BluE-PACK5.1)

NOTES

- Before connection, make sure that the voltages of the batteries are correct.
- Make sure that both the Battery Switch inside the cable box and the DC Switch inside the side cover of a battery pack are in the OFF state. For more information, see [Switches](#) of the inverter.

PROCEDURE

Step 1. On the battery packs, loosen the screws on the right side of the side covers and then remove the cover.

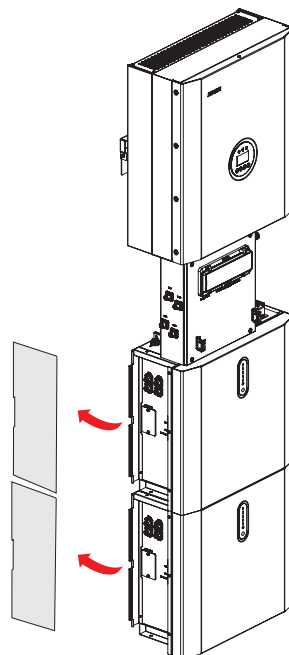

- Step 2.** Remove the screws from the PE port inside the cable box and the PE1 port on the side of the second battery pack. Use the 1000 mm PE cable (G-1000) to connect the ports and then replace the screws.

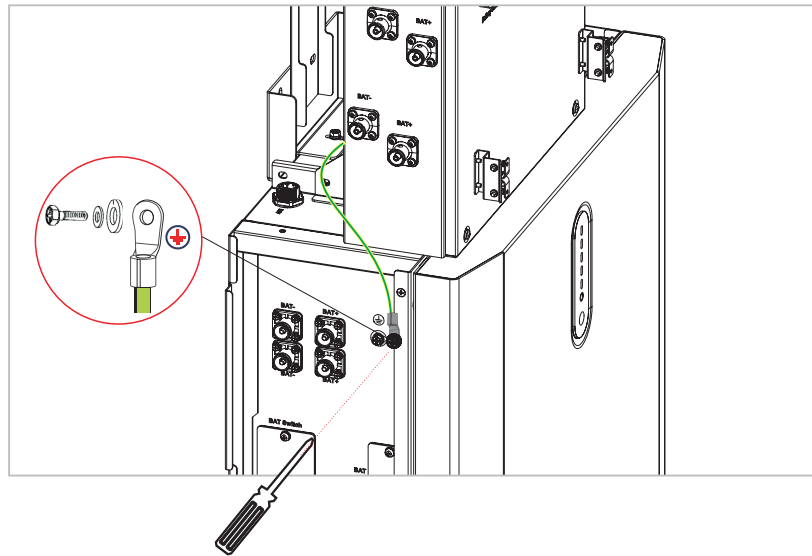

- Step 3.** Follow this diagram to make the connections:
- Use the 260 mm BAT cables (DR-260 and DB-260) to connect the BAT+ and BAT- ports inside the cable box and on the side of the second battery.
 - Use the 850 mm BAT cables (DR-850 and DB-850) to connect the BAT+ and BAT- ports inside the cable box and on the side of the first battery.
 - Use the 600 mm COM cable (C-600) to connect the BAT port inside the cable box and the INV port on the battery pack.
 - Use the 750 mm COM cable (C-750) to connect the lower BAT port of the second battery pack and the upper BAT port of the first battery pack.
 - Remove the screws from the PE2 ports of the battery packs, use a 520 mm PE cable (G-520) to connect the PE2 ports, and then replace the screws.

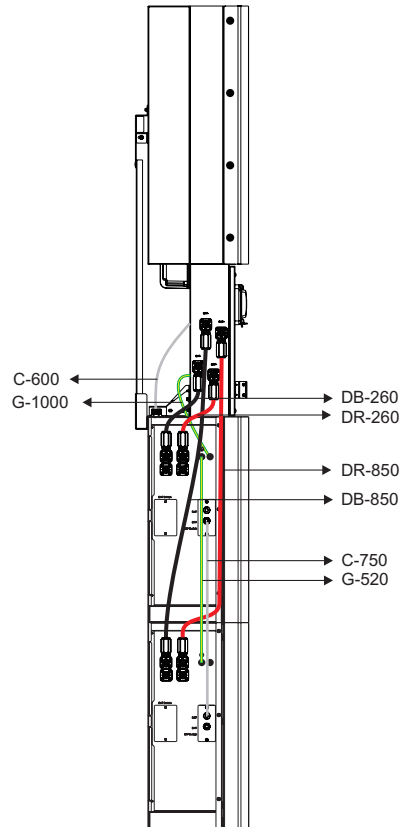

- Step 4.** On the second battery pack, assign its address: Turn the dip switch numbered 1 to the ON position and make sure that dip switches numbered 2, 3, and 4 are in the OFF state. For more information, see [Table 3-1](#).



The address of the battery pack directly connected to the inverter must be 1.

DO NOT change the state of Dip Switch 5.

- Step 5.** On the first battery pack, change the settings of the dip switches to assign its address to any address other than 1. For more information, see [Table 3-1](#).
- Step 6.** If you mounted four, six, or eight battery packs, connect them as shown in these diagrams.

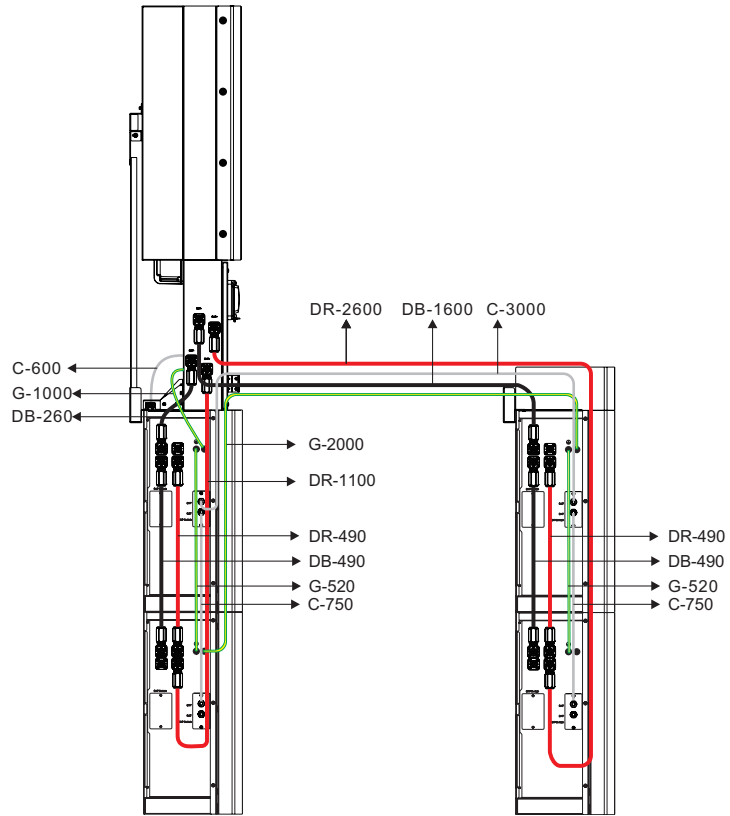

Figure 4-15 Connect Four BluE-PACK5.1

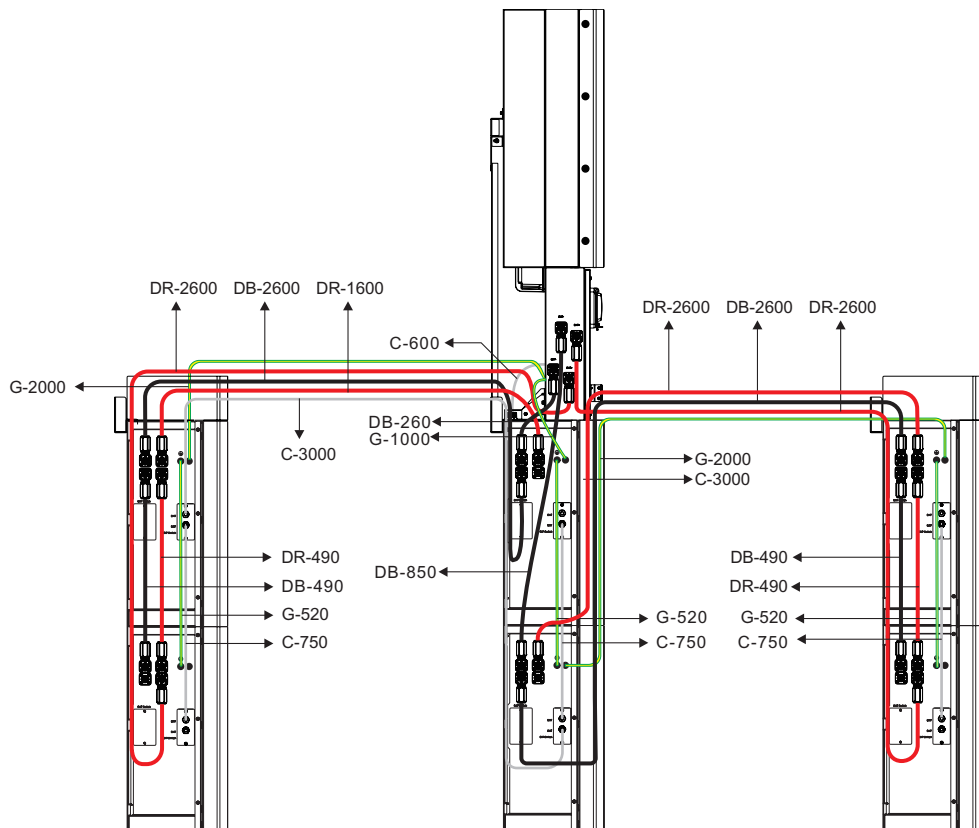

Figure 4-16 Connect Six BluE-PACK5.1

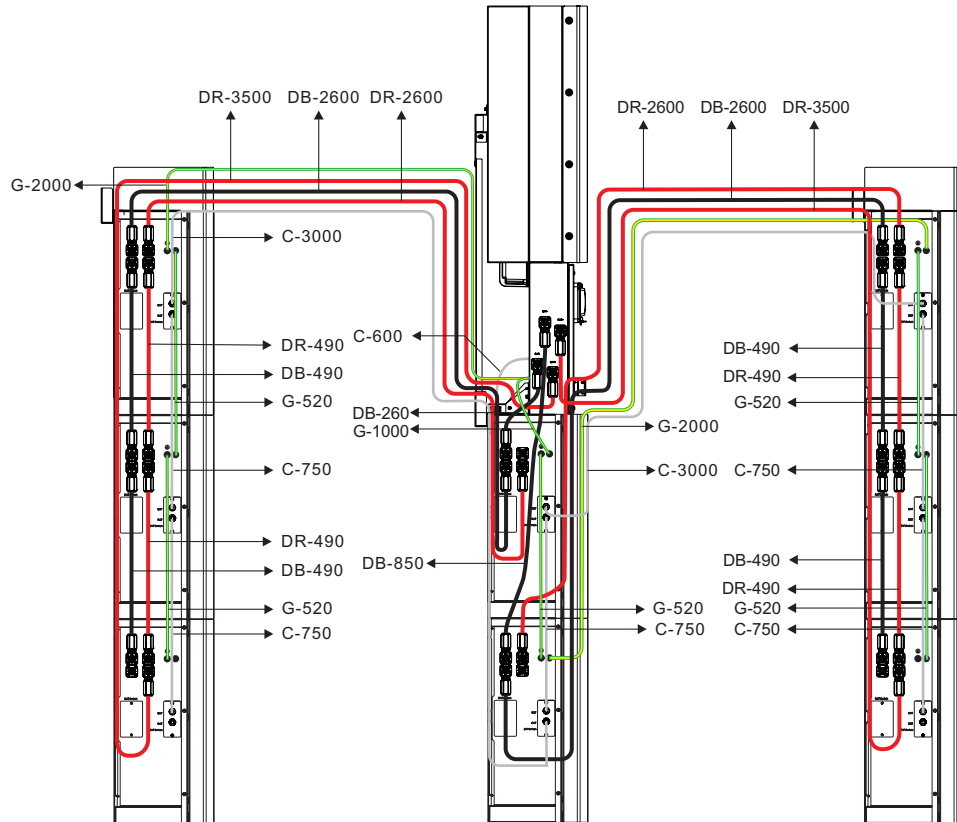

Figure 4-17 Connect Eight BluE-PACK5.1

Step 7. Change the settings of the dip switches to assign the addresses of other battery packs. For more information, see [Table 3-1](#).



You can assign the addresses to these battery packs in any order, but make sure that the addresses are not duplicated.
DO NOT change the state of Dip Switch 5.

Step 8. On the side of the battery pack, click the left side of the side cover into place and then replace the screws on the right side to secure the side cover to the battery pack.

Step 9. Put the top covers on the battery packs and tighten the screws as shown in these figures.

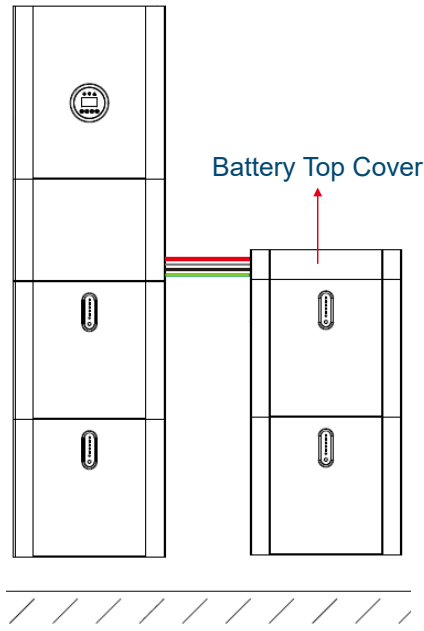

Figure 4-18 A System with Four BluE-PACK5.1 (With Top Covers)

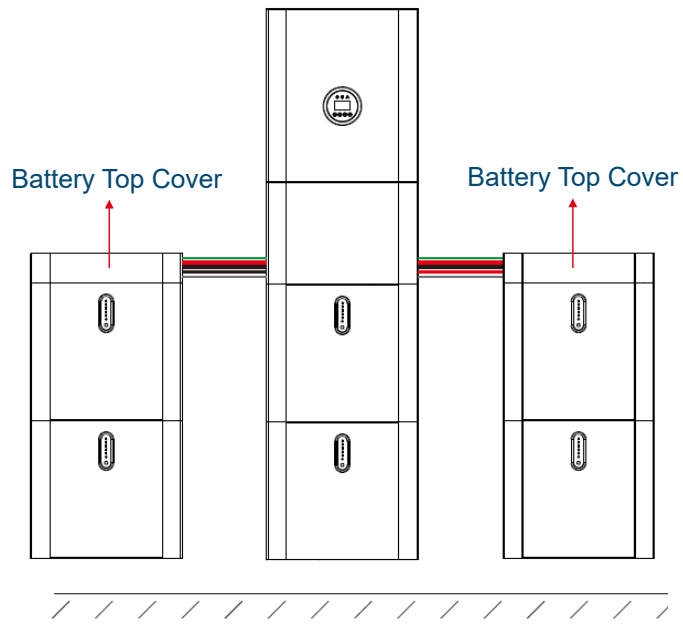

Figure 4-19 A System with Six BluE-PACK5.1 (With Top Covers)

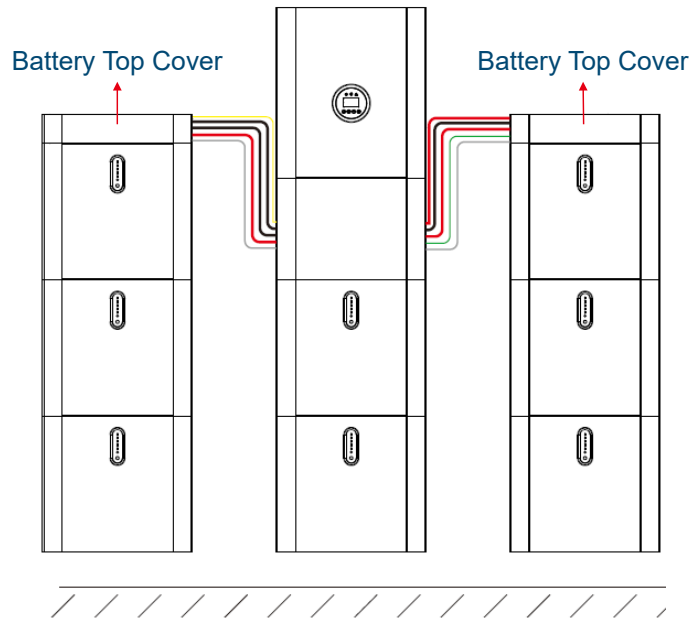

Figure 4-20 A System with Eight BluE-PACK5.1 (With Top Covers)

4.4.5 Connecting the Inverter and PV Solar Panels

NOTES

- 12 AWG or 4 mm² PV wires are recommended for connection.
- Distinguish the PV polarities and DO NOT reverse the connection.
- Make sure that the input voltage of the PV is within the acceptable input voltage range of the inverter, not higher than 1,000 V.

⚠ DANGER

Make sure that both the PV Switch inside the cable box and the switch on the PV solar panel are in the OFF position.

PROCEDURE

Step 1. Use a wire stripper to remove an approximately 8 mm length of insulation layer of the PV wire.

Step 2. Thread the stripped part of the PV wire into the case, use a cable crimper to crimp the case, insert the wire into the MC4 connector, and then tighten it.

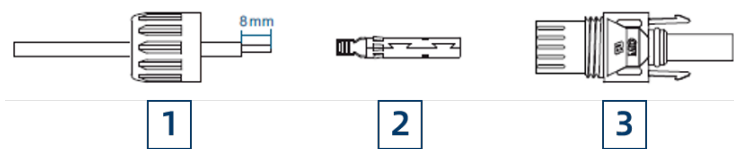

1 PV wire

2 Case

3 MC4 Connector

Step 3. Use a multi-meter to measure the voltage of the PV wire. Make sure that the voltage is lower than 1,000 V.

- Step 4.** Follow steps 1 through 3 to prepare other three PV wires for negative and positive connections.
- Step 5.** Plug the PV wires into the PV1+, PV1-, PV2+, and PV2- ports in the cable box and snap them.

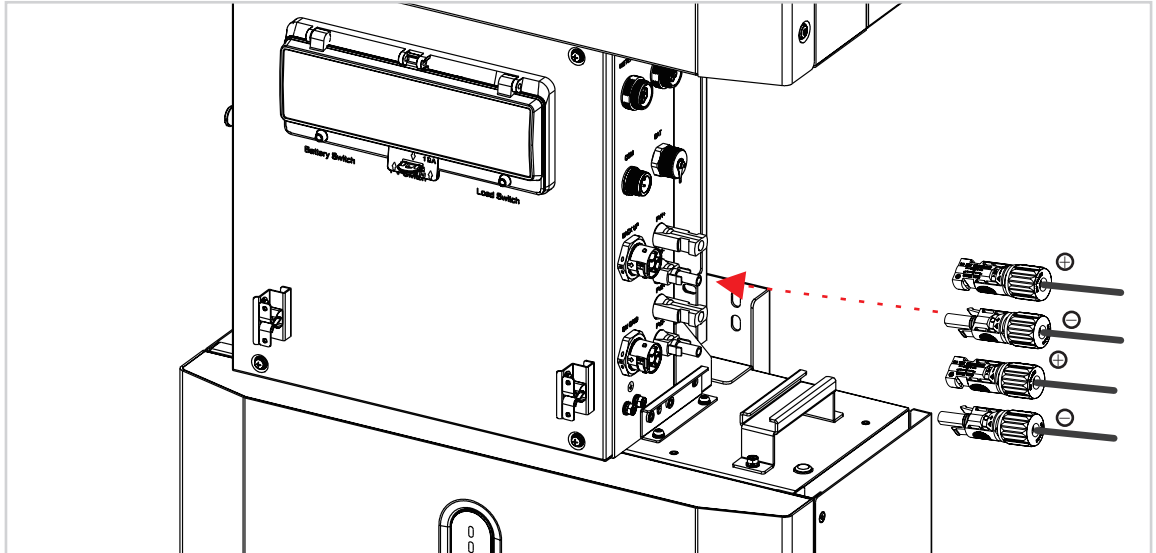

4.4.6 Connecting to Grid and Loads

NOTES

An AC connector is necessary for the connection. As shown in [Figure 4-21](#), the pins inside the AC connector are marked 1, 2, 3, N, and \perp . Pin 1, 2, and 3 must be connected to the live wires marked R, S, and T. Pin N must be connected to the neutral wire. Pin \perp must be grounded.

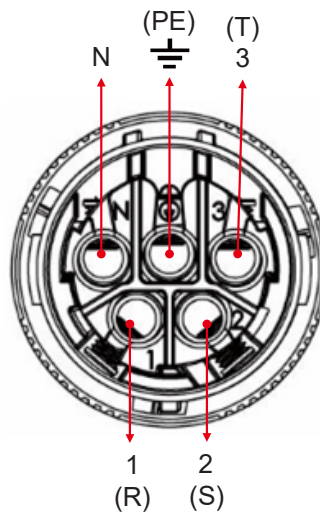

Figure 4-21 Pins of AC Connector

Two five-wire AC cables are necessary for ON GRID connection and BACK UP connection of the inverter.

NOTICE

- Recommended cables: a 12 AWG or 4-mm² cable for BACK UP connection and a 10 AWG or 6-mm² cable for ON GRID connection.
- Make sure that the resistance of the wires is lower than 1 Ω.
- Make sure that the grounding resistance, measured between the inverter case and the earth terminal of the distribution box, is less than 10 Ω.

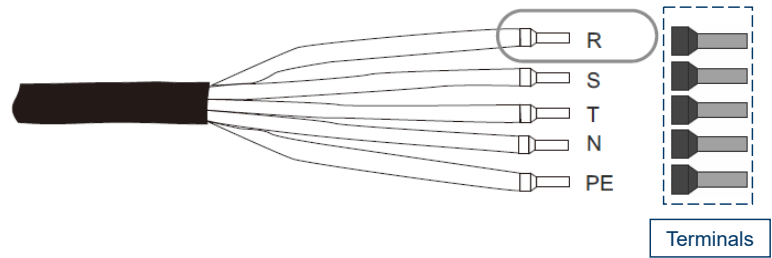

Figure 4-22 Five-wire AC Cable

| | |
|---|--|
| R: To be connected to Pin 1 of the AC connector to serve as the R phase wire. | S: To be connected to Pin 2 of the AC connector to serve as the S phase wire. |
| T: To be connected to Pin 3 of the AC connector to serve as the T phase wire. | N: To be connected to Pin N of the AC connector to serve as the neutral wire. |
| PE: To be connected to Pin \perp of the AC connector to serve as the earth wire. | Terminals: For crimping. |

⚠ DANGER

Before connection, make sure that the AC current breakers in the distribution box and the LOAD Switch inside the cable box are in the OFF state.

⚠ CAUTION

When connecting the wires to the connector, make sure that the phase wires, the neutral wire, and the earth wire are connected correctly.

⚠ CAUTION

Appliances such as air conditioners require sufficient time to equalize refrigerant gases within the circuit, so it takes at least two or three minutes to restart. If power supply is short-circuited and restored within a short period, it can cause damage to these appliances connected to the power supply. Before installing such appliances, make sure that the air conditioner has a time delay function to prevent such damage. In the absence of a time delay function, the inverter triggers an overload fault and cuts off the output to protect your appliances, but internal damage to appliances can sometimes still occur.



The type A or B RCD (≥ 300 mA) must be installed on the BACK UP port of the system according to local regulations.

An AC circuit breaker of these specifications is recommended:

- For ON-GRID connection: 32 A/400 VAC 6 KA
- For BACK UP connection: 25 A/400 VAC 6 KA

PROCEDURE

Step 1. Use a wire stripper to remove an appropriate length of the jacket and insulation layer from one wire of the AC cable. The length can be calculated with the length of the crimping terminal.

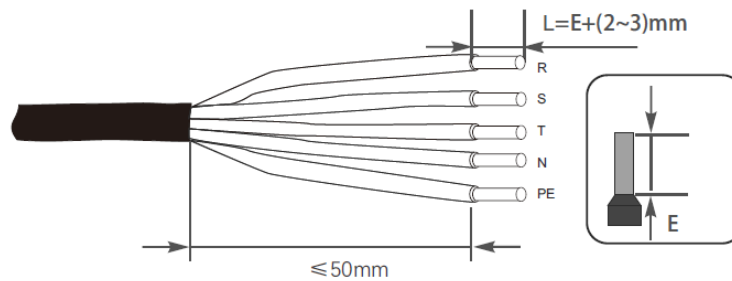

Step 2. Insert a wire into a terminal and then use a cable crimper to crimp the terminal.

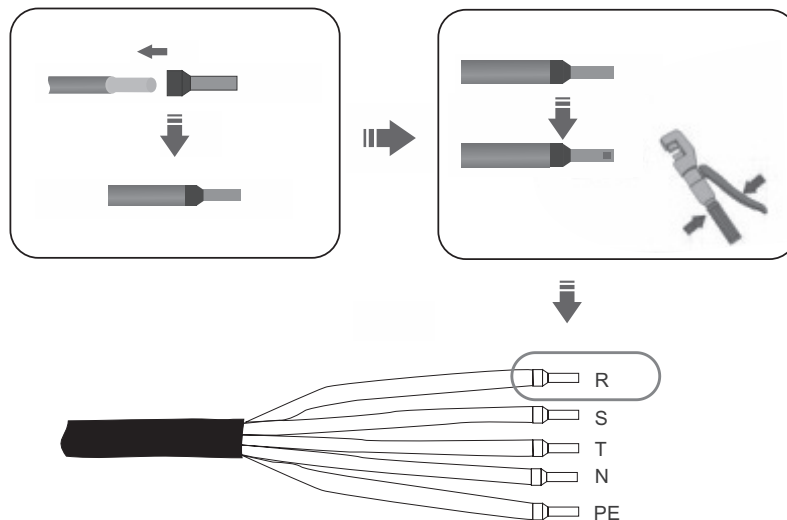

Step 3. Follow Step 1 and Step 2 to prepare the other four wires of the AC cable for connection.

Step 4. Unscrew the swivel nut from the threaded sleeve of the AC connector and thread the swivel nut and threaded sleeve onto the wires of the AC cable.

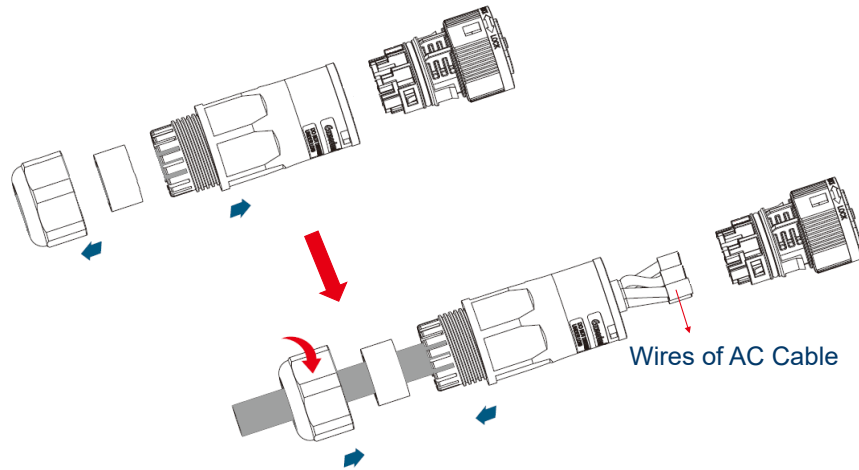

Step 5. Insert the crimped terminals into the corresponding pins of the AC connector and use a hex key wrench screwdriver (size: 2.5, 1.2–2.0 N.M) to tighten the screws.

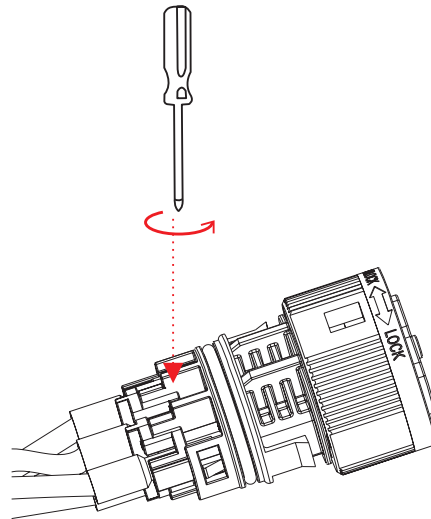

Step 6. Screw the swivel nut onto the threaded sleeve to seal the AC connector, protecting the AC cable from strain. When tightening, clamp the sleeve tightly with the locking cap to make sure that the swivel nut is screwed securely onto the threaded sleeve.

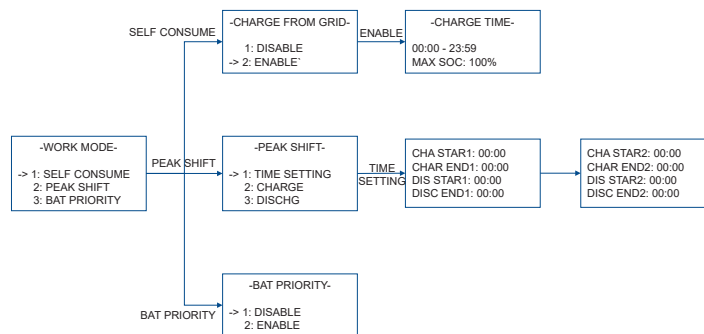

Step 7. Plug the AC connector into the ON GRID port inside the cable box and tighten the connector.

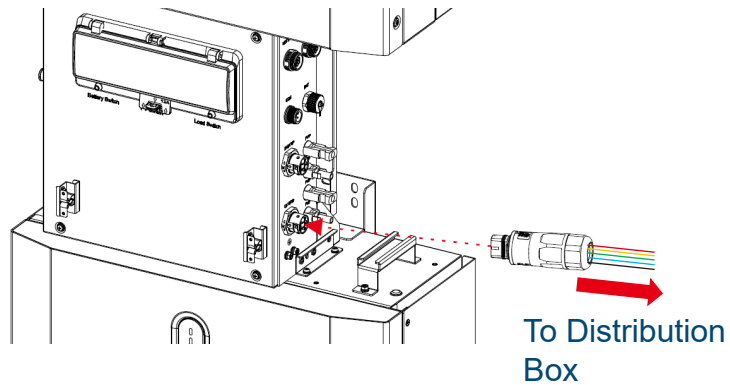

Step 8. Thread the other end of the AC cable into the distribution box. Ground the PE wire and connect the other four wires of the AC cable to the middle AC breaker. Follow this figure for wiring.

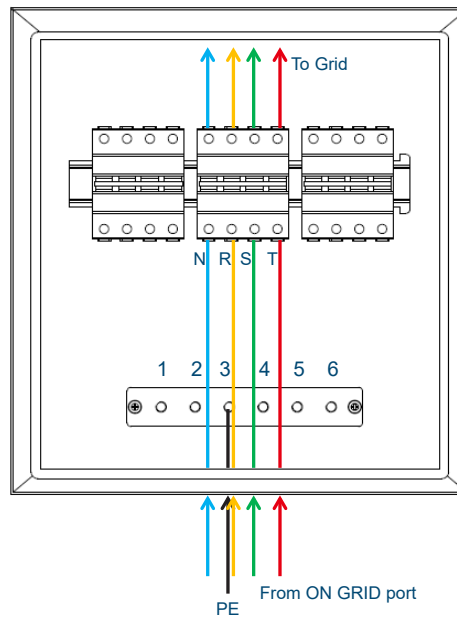

NOTICE

You should mark the R, S, and T wires when the power grid cable is locked into the external power grid connector, which makes CT connections easier.

Step 9. Use four wires to connect the middle and the left AC breakers and connect the left AC breaker to the normal loads. Follow this figure for wiring.

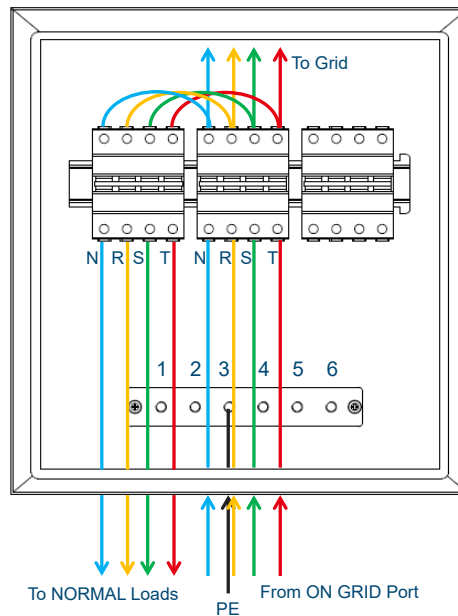

Step 10. Follow steps 1 through 6 to prepare the other AC connector and the AC cable.

Step 11. Plug the AC connector into the BACK UP port inside the cable box and tighten the connector.

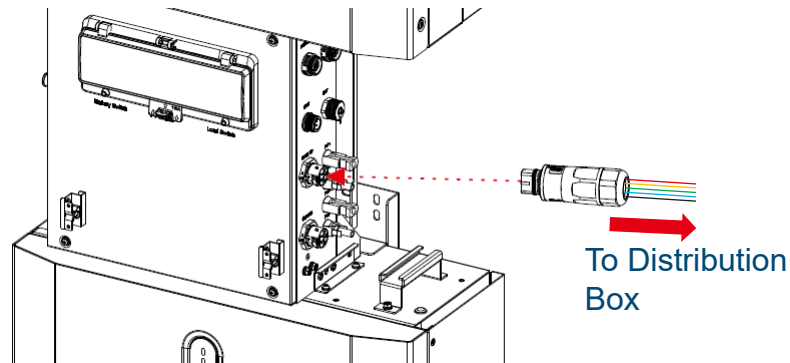

Step 12. Thread the other end of the AC cable into the distribution box. Ground the PE wire and connect the other four wires of the AC cable to the right AC breaker. Connect the right AC breaker to the backup loads. Follow this figure for wiring.

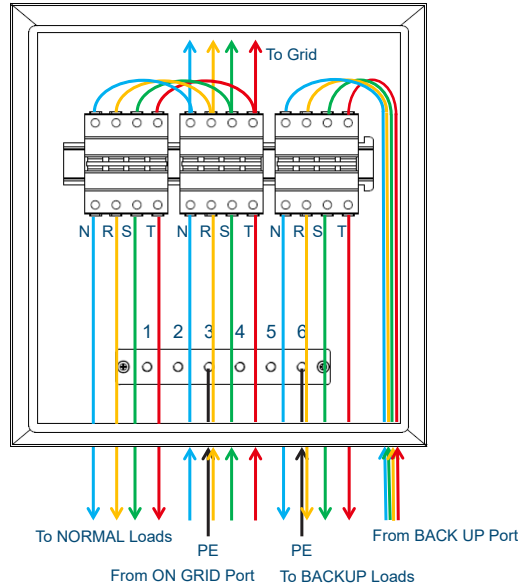

4.4.7 Connecting a Stick Logger

NOTES

For more information, see *Stick Logger Quick Guide*.

WARNING

DO NOT hold the logger body to rotate while installing or removing the logger.

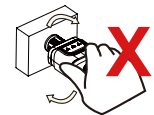

NOTICE

DO NOT remove waterproof plug.



PROCEDURE

Step 1. Plug the stick logger into the COM port inside the cable box.

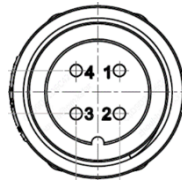

Figure 4-23 Pins of the COM Port

| |
|----------------|
| Pin 1: +5V |
| Pin 2: GND |
| Pin 3: RS485-A |
| Pin 4: RS485-B |

4.4.8 Connecting External CTs

You must connect external CTs or a smart grid meter between the inverter and the power grid.

If you want to connect a smart meter, see [Connecting a Smart Meter](#).

If you want to connect external CTs, three CTs and a CT&Meter connector are necessary. The connector has six pins, as shown in [Figure 4-24](#). For more information, see Step 2 in the procedure.

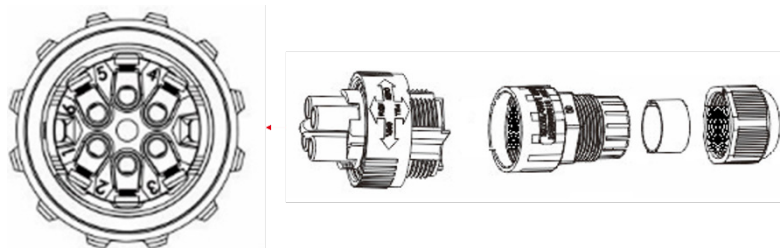

Figure 4-24 Pins of CT&Meter Connector

NOTES

Only the CTs provided by the manufacturer can be connected to the system.

You must mark the CTs as R, S, and T.

The external CTs must be mounted near the power grid side. If the CT test passes but the inverter output power is not acceptable, for example, power cannot be controlled or output power is always 0 W, check the position where the CTs are mounted.

You can run a CT self-check. For more information, see [CT SELF CHK](#).

PROCEDURE

Step 1. Unscrew the nut, sealing, body, and housing of the CT connector.

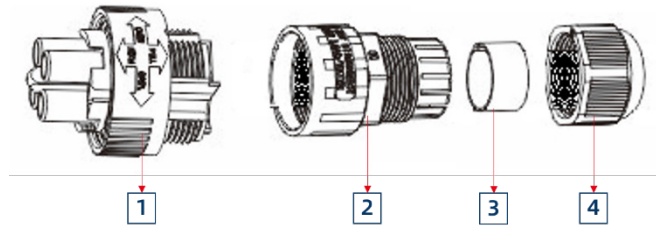

- 1** Housing **2** Body **3** Sealing **4** Nut

Step 2. Thread the wires of the CTs through the nut, sealing, and the body, insert them into the pins of the CT&Meter connector, and then tighten the screws.

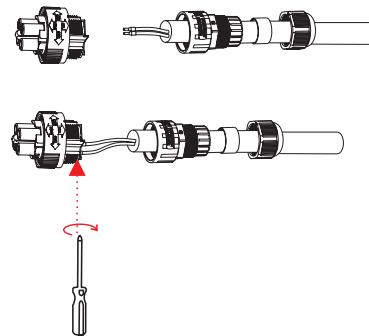

| Pin | To Connect | Pin | To Connect |
|----------|----------------------------------|----------|----------------------------------|
| 1 | R phase CT positive pole (White) | 2 | R phase CT negative pole (Black) |
| 3 | S phase CT positive pole (White) | 4 | S phase CT negative pole (Black) |
| 5 | T phase CT positive pole (White) | 6 | T phase CT negative pole (Black) |

Step 3. Tighten the nut, sealing, body, and housing of the CT&Meter connector.

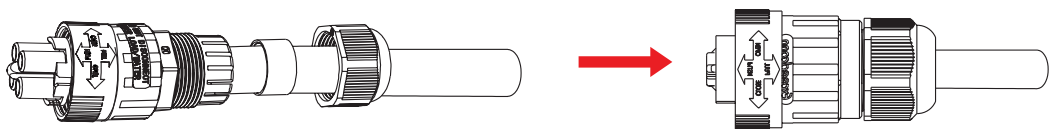

Step 4. Plug the CT&Meter connector into the CT port inside the cable box and tighten it.

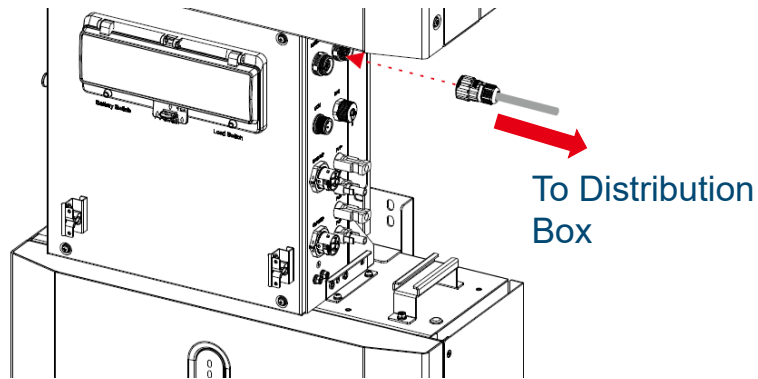

Step 5. Open the terminals of the CTs, put the R, S, and T wires of the AC cable for the normal loads into the slots of the R, S, and T CTs, and finally fasten the clasps. Follow this figure for wiring.

The arrows on the CTs must point toward the power grid.

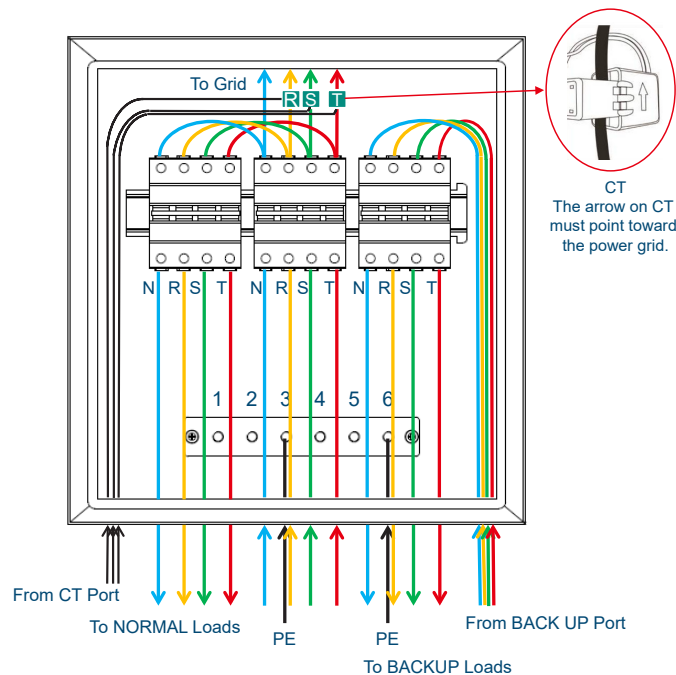

Step 6. If no further electrical connections are necessary, close the cover of the cable box, tighten the screws, and then go to Commissioning.

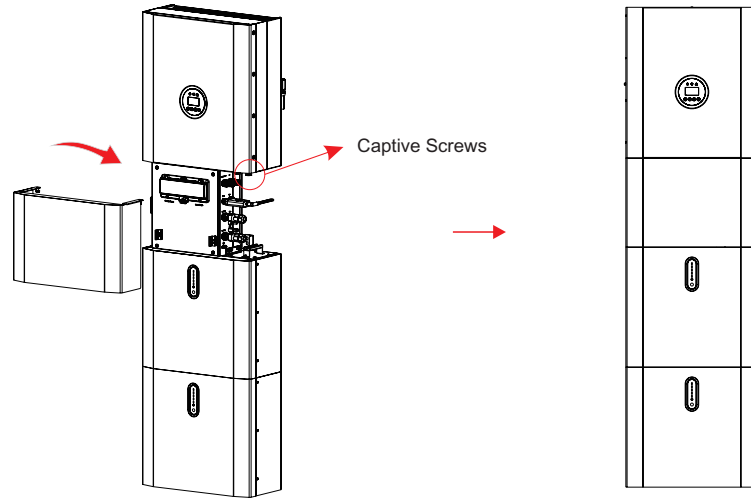

4.4.9 Connecting a Smart Meter

You must connect external CTs or a smart grid meter between the inverter and the power grid.

If you want to connect external CTs, see [Connecting External CTs](#).

If you want to connect a smart meter, note that only one meter is necessary for each inverter. The meter must be mounted and connected at the grid transition point (feed-in point) so that it can measure the grid reference and feed-in power.

To connect a smart meter, a CT&Meter connector is necessary and it must be connected to the METER+DRY port inside the cable box.

Table 4-3 Pin Description of METER+DRY Port

| | PIN | Description |
|--|-----|--------------|
| | 1 | DRY contact |
| | 2 | DRY contact |
| | 3 | GND |
| | 4 | Input signal |
| | 5 | RS485-B |
| | 6 | RS485-A |

NOTES

NOTICE

Currently, only these brands of smart meters are supported: Eastron, Acrel, Rayleigh, YaDa, and CHNT. You can set the smart meter brand in the integrated EMS. For more information, see the **CT OR METER** subsection under **SYS SETTING**.

The Eastron SDM630MCT-40mA is recommended. The smart meter with CTs is already configured. **DO NOT** change any settings on the smart meter.

PROCEDURE

- Step 1.** Prepare the communication wires, power cable, and tools for the meter connection.
- Step 2.** Follow the meter installation manual to install the meter.

 NOTE

The arrow on the CT must point toward the power grid.
Three CTs must be used for one smart meter and must be connected to the same phase with the smart meter power cable.

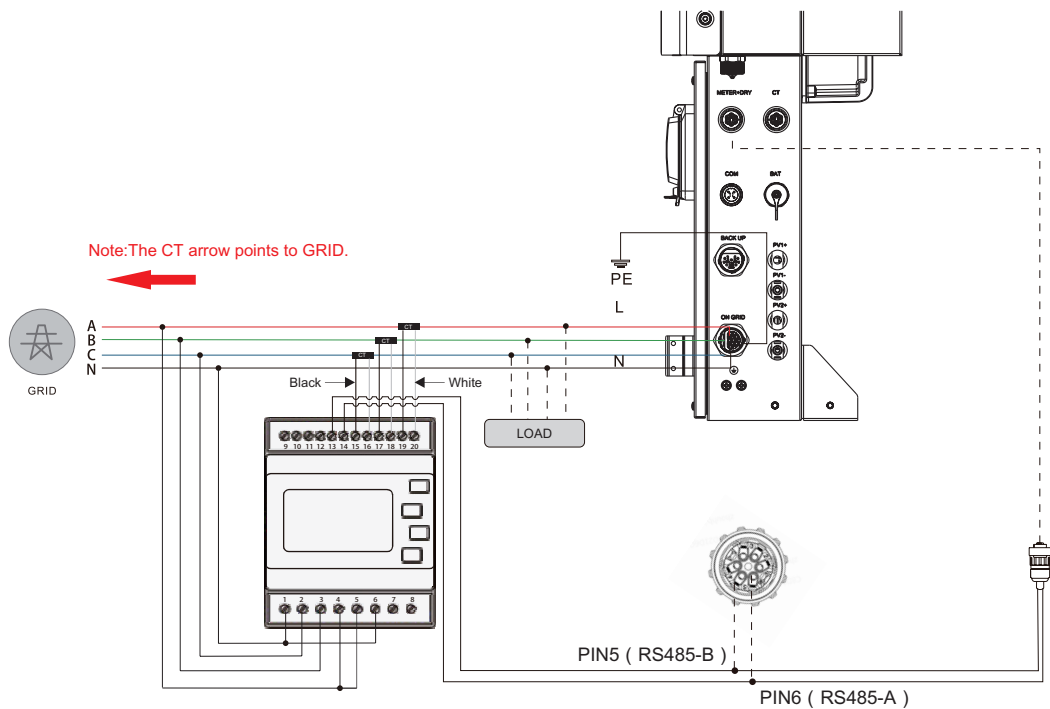
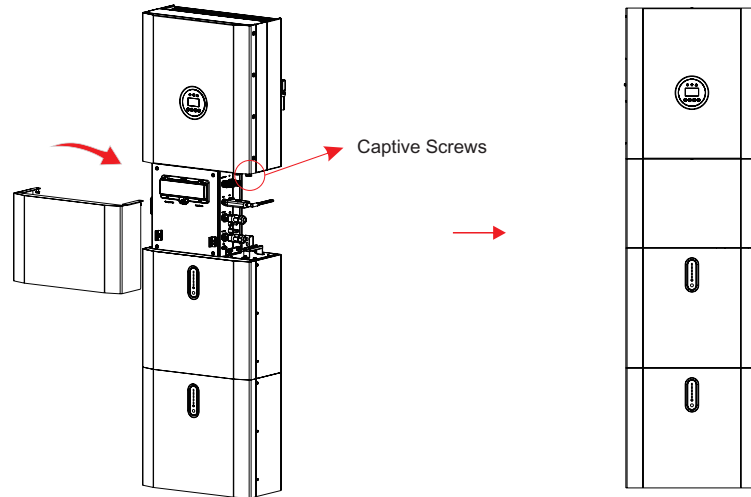

Figure 4-25 Wiring of Smart Meter Connection (Example, SDM630MCT-40mA)

- Step 3.** On the inverter side, follow steps 1 through 3 of Connecting External CTs to process the communication wire, plug the connector into the METER+DRY port inside the cable box, and then tighten it.
- Step 4.** If no further electrical connections are necessary, close the cover of the cable box, tighten the screws, and then go to Commissioning.



4.4.10 (Optional) Connecting a DRED or an RRRCR

NOTES

The E8KT/E10KT/E12KT complies with AS/NZS 4777.2:2015 standard. Its DRM port can be connected to a Demand Response Enabling Device (DRED) in Australia or New Zealand or a Radio Ripple Control Receiver (RRRCR) in other areas or countries.



When the Australia or the New Zealand grid standard is selected, the DRM port can be enabled to connect a DRED. When other grid standards are selected, this port can be enabled to connect an RRRCR. For more information about grid standards, see [GRID STD.](#)

A DRM connector is necessary for the connection. [Table 4-4](#) shows the pin descriptions of the DRM connector.

Table 4-4 DRM Connector Pin Descriptions

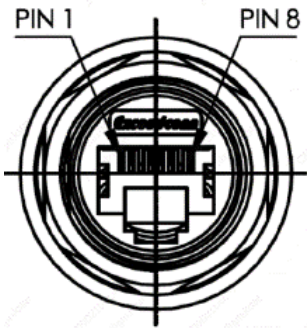
|  | Pin | Pin Name |
|---|--------|------------|
| | 1 | REF GEN/0 |
| | 2 | 5Vdc |
| | 3 | COM LOAD/0 |
| | 4 | 5Vdc |
| | 5 | DRM1/5 |
| | 6 | DRM2/6 |
| | 7 | DRM3/7 |
| 8 | DRM4/8 | |

The E8KT/E10KT/E12KT is pre-configured to the following Radio Ripple Control Receiver (RRCR) power levels as shown in [Table 4-5](#).



In the “PINx” columns, “0” means the corresponding relay is closed and “1” means the corresponding relay is opened.

Table 4-5 RRCR Power Level

| PIN8 | PIN7 | PIN6 | PIN5 | PIN3 | Active Power | Cos(Q) |
|------|------|------|------|------|--------------|--------|
| 1 | 0 | 1 | 1 | 1 | 0% | 1 |
| 1 | 1 | 0 | 1 | 1 | 30% | 1 |
| 1 | 1 | 1 | 0 | 1 | 60% | 1 |
| 1 | 1 | 1 | 1 | 0 | 100% | 1 |
| 1 | 1 | 1 | 1 | 1 | 100% | 1 |
| 0 | X | X | X | X | Standby | 1 |

PROCEDURE

- Step 1.** Make sure that DRM is enabled in the integrated EMS. For more information, see the [DRM ENABLE](#) subsection under [SYS SETTING](#).
- Step 2.** Use the DRM connector to connect the DRM port inside the cable box to the external device.

To connect a DRED, follow this figure for wiring.

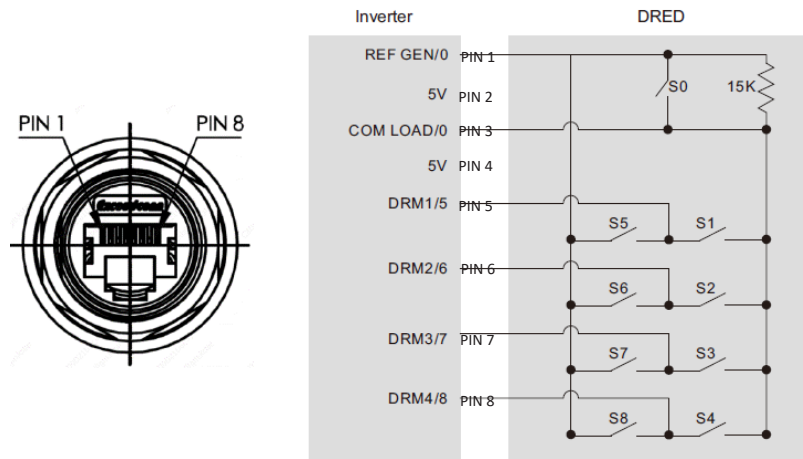

To connect an RRRCR, follow this figure for wiring.

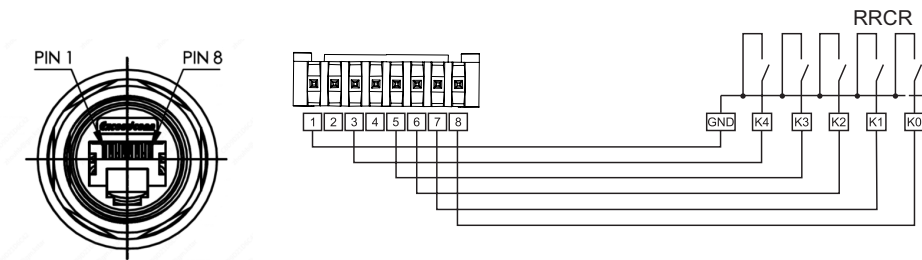

4.4.11 (Optional) Connecting a Generator

If you are using a generator, you can connect the generator to the E8KT/E10KT/E12KT energy storage system.

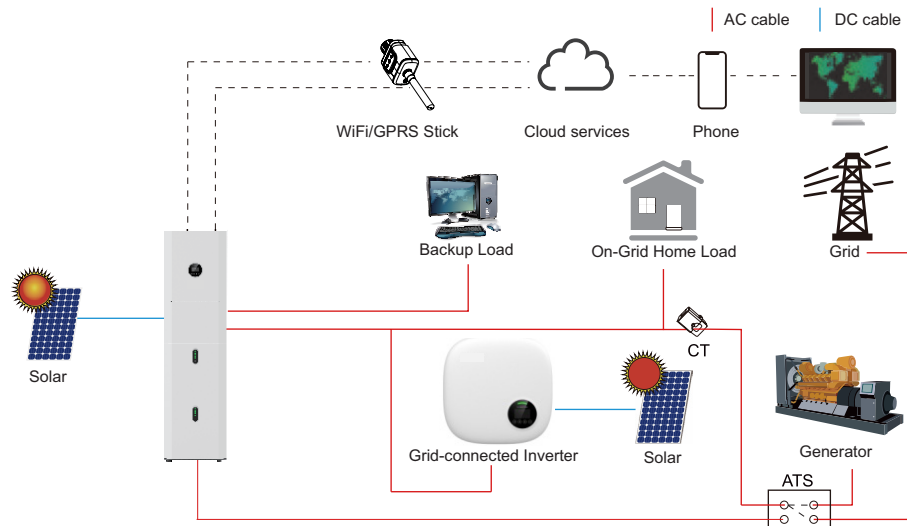

Figure 4-26 Connect a Generator

4.5 Installing a Parallel System

The E8KT/E10KT/E12KT supports installation of a parallel system with more than one inverter. A maximum of four inverters can be connected in parallel. For more information, see [Parallel System](#).

4.5.1 Wiring of a Parallel System

Follow these figures for wiring of a parallel system with two, three, or four inverters.

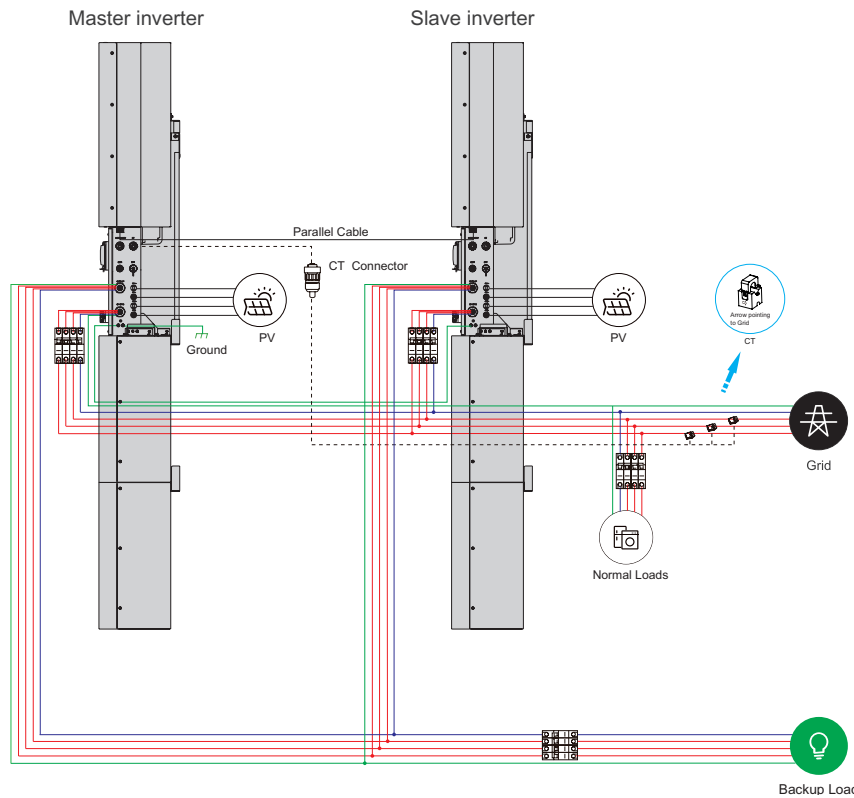

Figure 4-27 Wiring of a Parallel System with Two Inverters

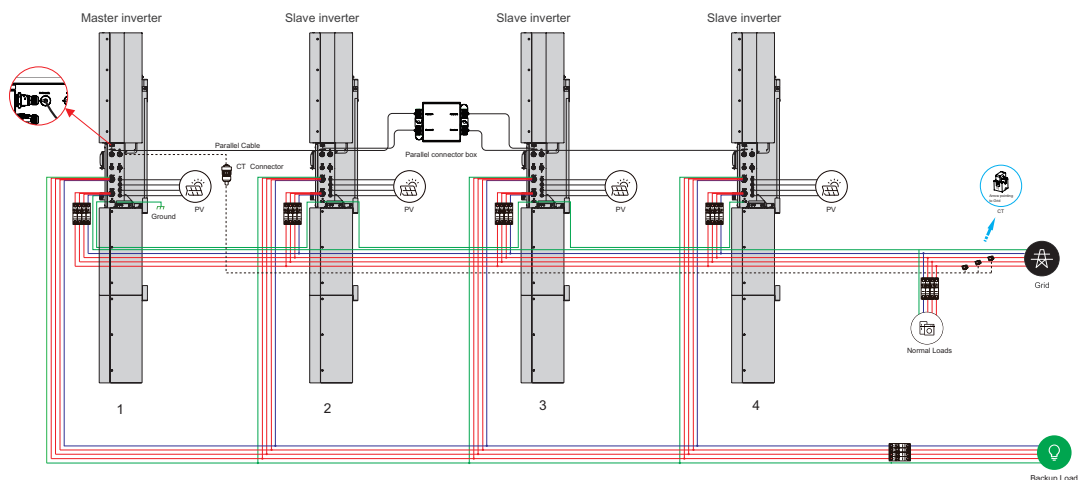

Figure 4-28 Wiring of a Parallel System with Four Inverters

4.5.2 Installation Prerequisites

Make sure that all the inverters are mounted and connected to the PV solar panels. For more information, see [Mounting the Inverter](#) and [Connecting Battery Packs \(BluE-PACK5.1\)](#)

NOTES

Before connection, make sure that the voltages of the batteries are correct.

Make sure that both the Battery Switch inside the cable box and the DC Switch inside the side cover of a battery pack are in the OFF state. For more information, see [Switches](#) of the inverter.

PROCEDURE

Step 1. On the battery packs, loosen the screws on the right side of the side covers and then remove the cover.

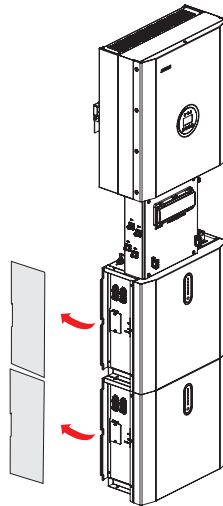

Step 2. Remove the screws from the PE port inside the cable box and the PE1 port on the side of the second battery pack. Use the 1000 mm PE cable (G-1000) to connect the ports and then replace the screws.

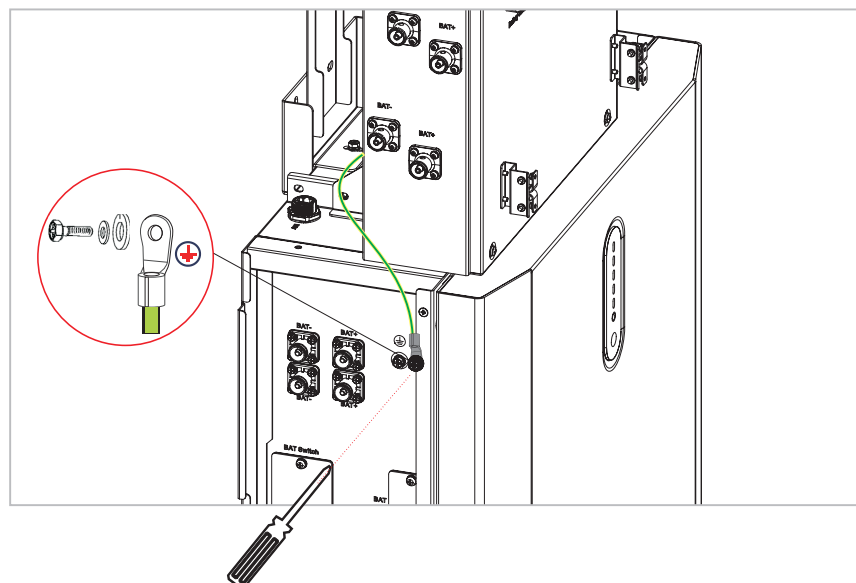

Step 3. Follow this diagram to make the connections:

- Use the 260 mm BAT cables (DR-260 and DB-260) to connect the BAT+ and BAT- ports inside the cable box and on the side of the second battery.
- Use the 850 mm BAT cables (DR-850 and DB-850) to connect the BAT+ and BAT- ports inside the cable box and on the side of the first battery.
- Use the 600 mm COM cable (C-600) to connect the BAT port inside the cable box and the INV port on the battery pack.
- Use the 750 mm COM cable (C-750) to connect the lower BAT port of the second battery pack and the upper BAT port of the first battery pack.
- Remove the screws from the PE2 ports of the battery packs, use a 520 mm PE cable (G-520) to connect the PE2 ports, and then replace the screws.

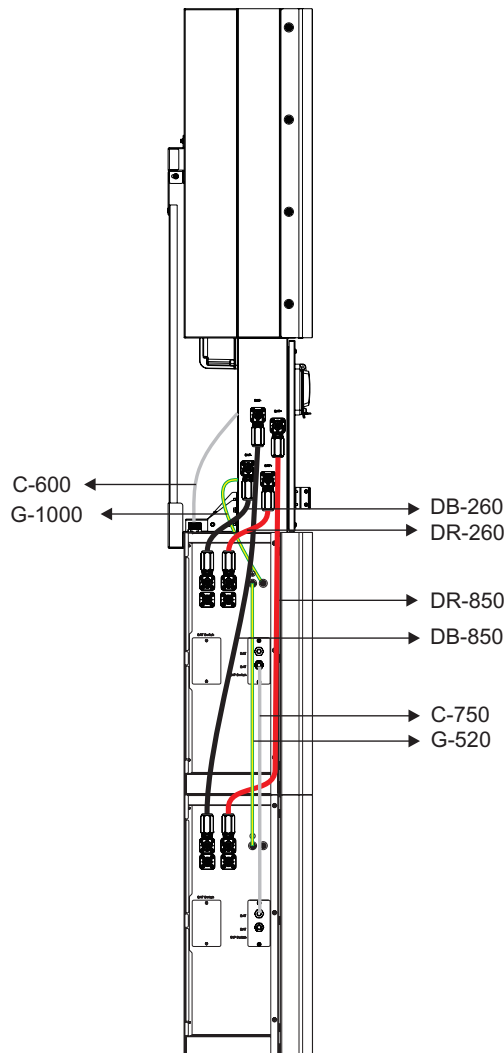

- Step 4.** On the second battery pack, assign its address: Turn the dip switch numbered 1 to the ON position and make sure that dip switches numbered 2, 3, and 4 are in the OFF state. For more information, see [Table 3-1](#).



The address of the battery pack directly connected to the inverter must be 1.
DO NOT change the state of Dip Switch 5.

- Step 5.** On the first battery pack, change the settings of the dip switches to assign its address to any address other than 1. For more information, see [Table 3-1](#).
- Step 6.** If you mounted four, six, or eight battery packs, connect them as shown in these diagrams.

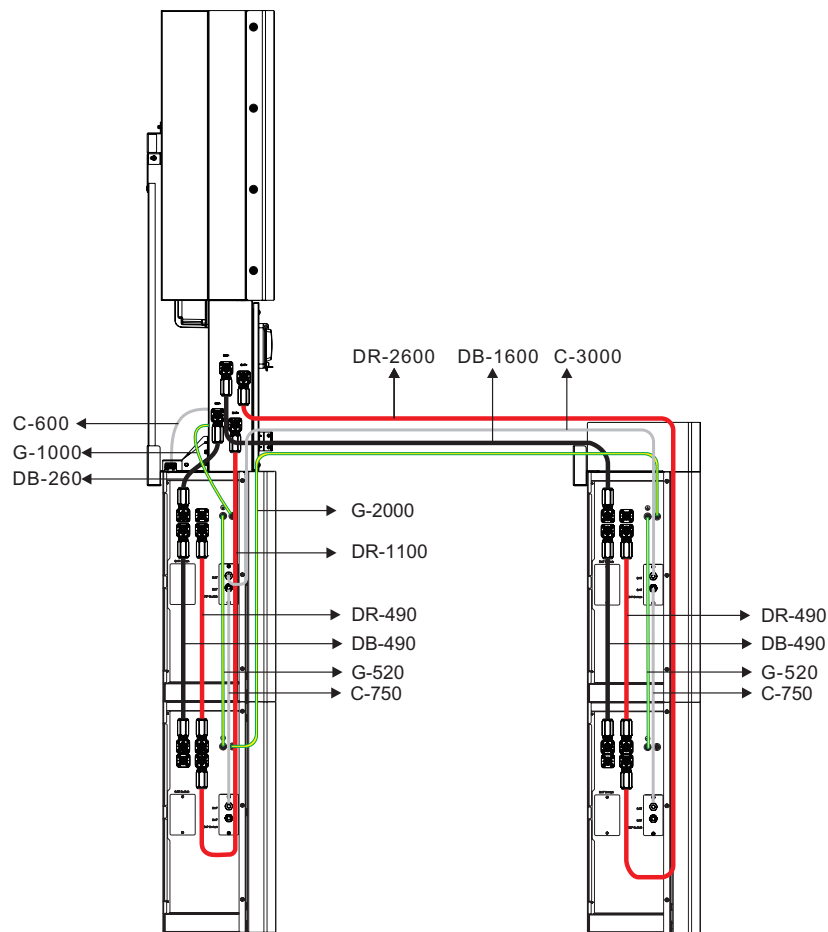

Figure 4-29 Connect Four BluE-PACK5.1

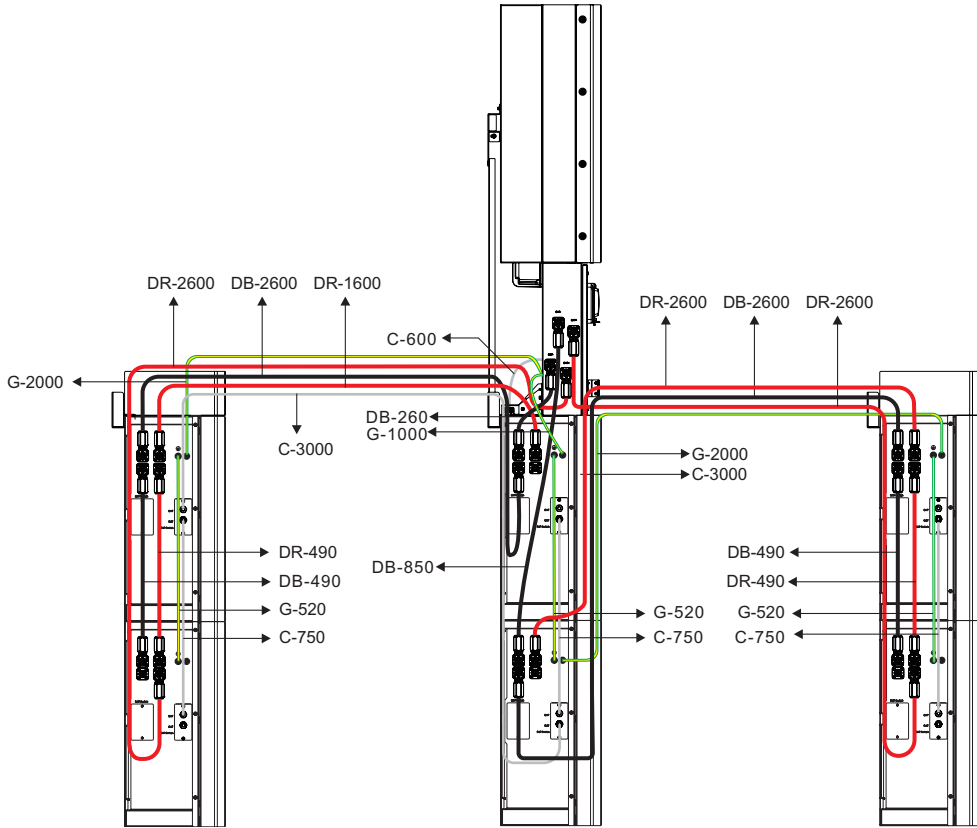

Figure 4-30 Connect Six BluE-PACK5.1

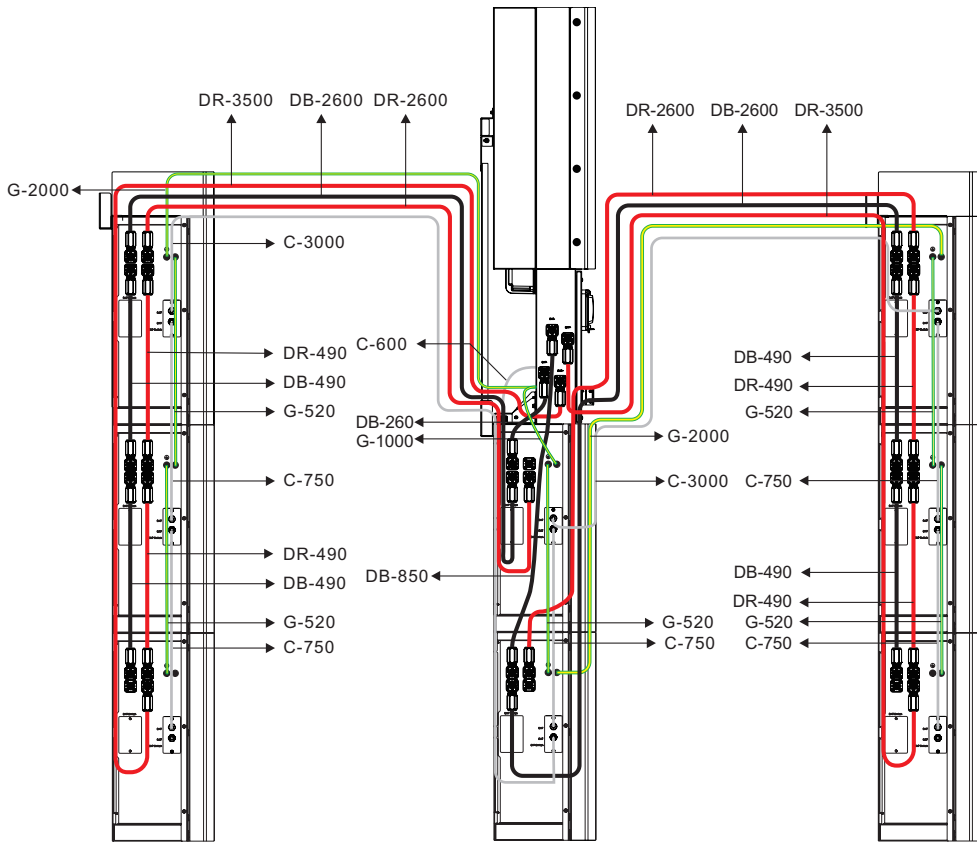

Figure 4-31 Connect Eight BluE-PACK5.1

Step 7. Change the settings of the dip switches to assign the addresses of other battery packs. For more information, see [Table 3-1](#).



You can assign the addresses to these battery packs in any order, but make sure that the addresses are not duplicated.
DO NOT change the state of Dip Switch 5.

Step 8. On the side of the battery pack, click the left side of the side cover into place and then replace the screws on the right side to secure the side cover to the battery pack.

Step 9. Put the top covers on the battery packs and tighten the screws as shown in these figures.

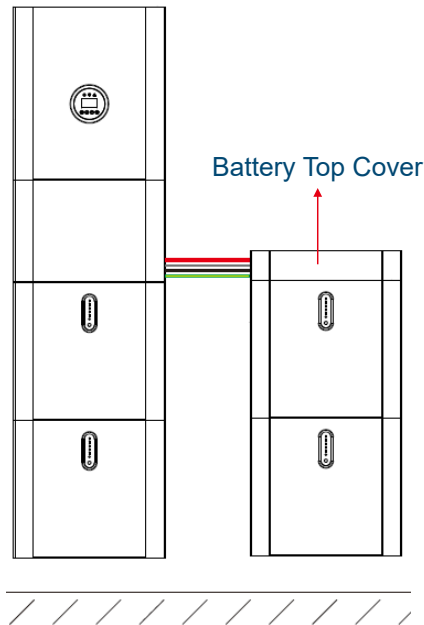

Figure 4-32 A System with Four BluE-PACK5.1 (With Top Covers)

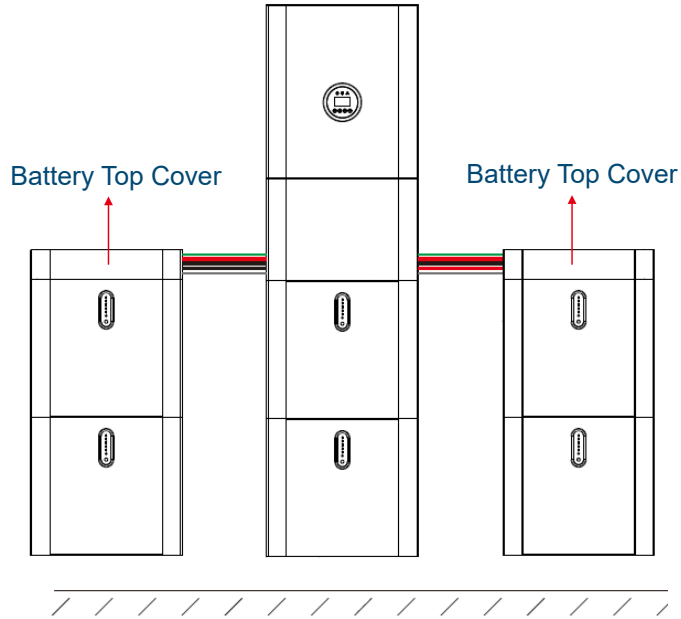

Figure 4-33 A System with Six BluE-PACK5.1 (With Top Covers)

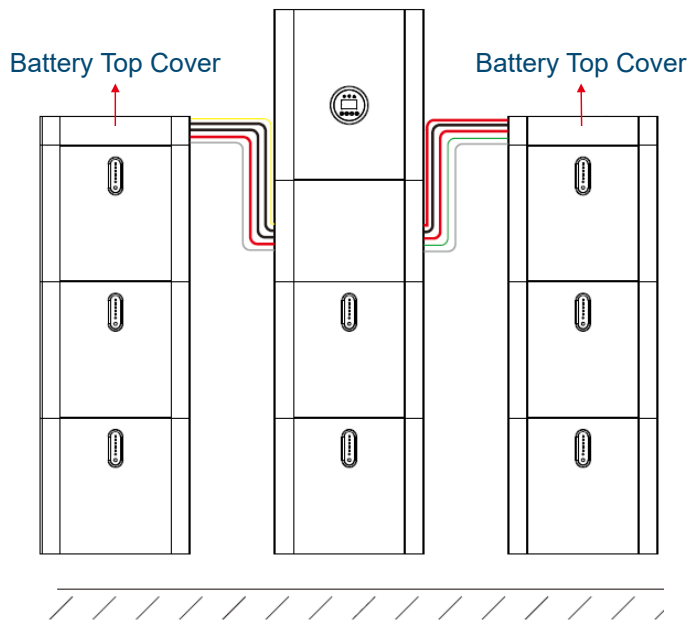

Figure 4-34 A System with Eight BluE-PACK5.1 (With Top Covers)

- Connecting the Inverter and PV Solar Panels.
- Make sure that all the battery packs are mounted and connected. For more information, see [Mounting Battery Packs](#) and [Connecting Battery Packs \(BluE-PACK-5.1-16S-100A-F\)](#).
- Make sure that the grid and load connections to each inverter are correct. For more information, see [Connecting to Grid and Loads](#).
- Decide which inverter serve as the primary inverter.



Make sure that only the primary inverter connects a set of CTs or an electricity meter. DO NOT connect CTs or an electricity meter to the subordinate inverters. For more information, see [Connecting External CTs](#) or [Connecting a Smart Meter](#).

- Make sure that the AC circuit breakers in the distribution box are in the OFF state.
- Prepare the parallel connectors and parallel connector box for parallel connection.



If more than two inverters are to be connected in parallel, a parallel connector box is necessary. The parallel connector box is ordered separately.

- Prepare an 8-core Category-6 cable. The recommended length is no more than 10 m.

Table 4-6 QTY of Cables and Parallel Connector Boxes for a Parallel System

| Inverter | Cable | Parallel Connector Box |
|----------|-------|------------------------|
| 2 | 1 | 0 |
| 3 | 3 | 1 |
| 4 | 4 | 1 |

- Check the package of the parallel connector box.

| | |
|--------------------------------------|-------------------------------|
| | |
| <p>1 × Parallel Connector Box</p> | <p>5 × Parallel Connector</p> |
| | |
| <p>2 × ST6.3*50 & 2 × D10*50</p> | <p>2 × M6 Gasket</p> |

Table 4-7 Pin Description of the Parallel Ports of Parallel Connector Box

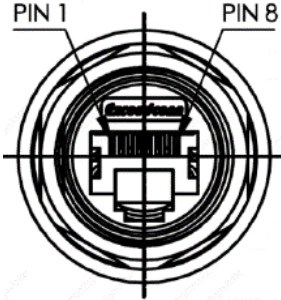
|  | Pin | Description |
|---|---------|----------------|
| | 1 | CAN_H |
| | 2 | CAN_L |
| | 3 | INV_STATUS_BC |
| | 4 | BPSIDE_HOLD_BC |
| | 5 | MASTER_SYN_BC |
| | 6, 7, 8 | GND |

4.5.3 Installation Procedure

- Step 1.** Align the parallel connector box with the wall. Use a leveling instrument to make sure it is level.
- Step 2.** Drill two holes, use the rubber mallet to drive ST6.3*50 into the holes, and then use the gaskets and the D10*50 expansion screws to fix the connector box to the wall.
- Step 3.** On the PARALLEL port of an inverter, unscrew the parallel connector, thread one end of a cable into the connector and tighten it, and then screw the connector into the PARALLEL port.
- Step 4.** If only two inverters are connected in parallel, repeat Step 3 on the other inverter.
If three or four inverters are to be connected, unscrew the parallel connector from the Parallel 1 port of the parallel connector box, thread the other end of the first cable through the parallel port of the box, and tighten it.

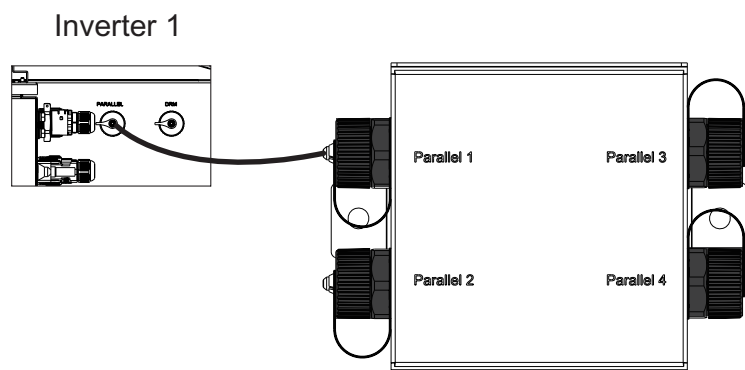

Step 5. If three or four inverters are connected, repeat Step 4 to connect all inverters through the Parallel 2, Parallel 3, and Parallel 4 ports of the parallel connector box.

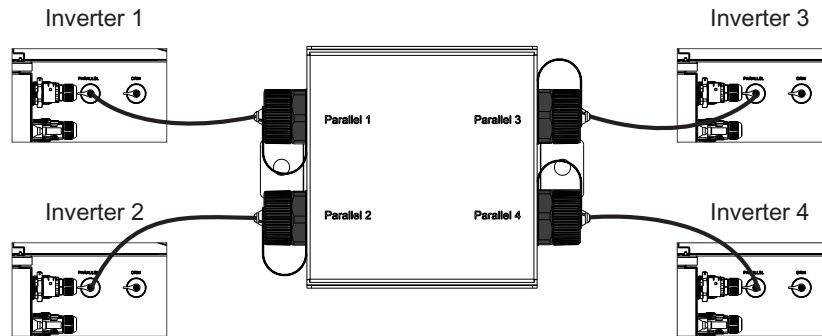

If parallel cable connection is completed incorrectly, an F22 error occurs. For more information about the error, see [Error Codes of the System](#).

Step 6. Check the connections.

CAUTION

To protect the inverter from burning, the R, S, T, and N connection for the ON-GRID connection and the BACK UP connection must be completed correct.

Step 7. Power on all the inverters of the parallel system. For more information, see [Powering On](#).

Step 8. On the LCD screen of the primary inverter, enable the parallel feature and set the address to 1. For more information, see the [PARALLEL](#) subsection under [SYS SETTING](#).

Step 9. On the LCD screens of the other inverters, enable the parallel feature and set the address to 2, 3, or 4. For more information, see the [PARALLEL](#) subsection under [SYS SETTING](#).



If the address setting is incorrect, an F22 error occurs. For more information about the error, see [Error Codes of the System](#).

Step 10. If external CTs are connected to the primary inverter, disconnect all the subordinate inverters, and run a CT SELF-CHECK. For more information, see [CT SELF CHK](#).

5 Commissioning

Follow the steps in [Figure 5-1](#) to commission the system.

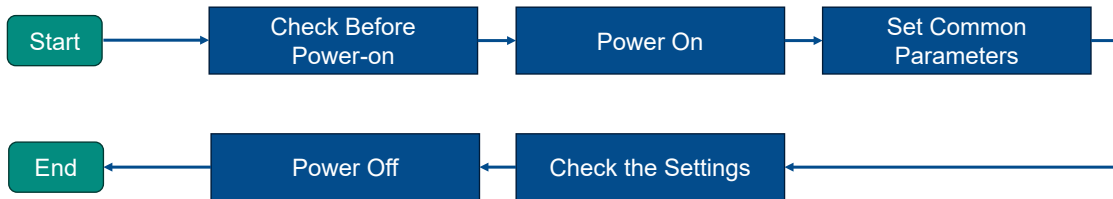

Figure 5-1 Commissioning Procedure

5.1 Checking Before Power-on

Before powering on the system, thoroughly check the installation.

- Step 1.** Make sure that the E8KT/E10KT/E12KT is firmly fastened to the mounting panel on the wall.
- Step 2.** Check the electrical connection inside the cable box. Make sure that:
- PV+ and PV- cables are firmly connected and the polarity and voltage are correct.
 - The ON GRID and Back Up cables are connected firmly and correctly.
- Step 3.** Check the electrical connection in the distribution box. Make sure that:
- The AC circuit breakers for the normal loads are correctly connected.
 - The AC circuit breakers for the backup loads are correctly connected.
 - Both breakers are in the OFF state.
- Step 4.** Open the side covers of the battery packs and make sure the COMM connections are correct.

5.2 Powering On

NOTICE

If PV output voltage is 0 V in sunlight, check the PV connection. Check for reverse connection of the PV and make sure that the circuit connection is correct.

- Step 1.** Turn on the external PV switch.
- Step 2.** Open the cover of the cable box.
- Step 3.** In the distribution box, turn on the AC current breaker between the ON GRID port and the grid.
- Step 4.** In the cable box, turn on the PV Switch.
- Step 5.** Turn on the battery pack. For more information, see [Turning on a Battery Pack](#).
- Step 6.** Open the side cover of the battery pack and turn on the DC Switch. If more than one battery pack is installed, repeat steps 5 and 6.

- Step 7.** In the cable box, turn on the Battery Switch.
- Step 8.** In the distribution box, turn on the AC breaker between the Back Up port and the backup loads.
- Step 9.** If backup loads are applied, turn on the LOAD Switch in the cable box.

 The LOAD Switch is necessary only when a backup load is connected.

- Step 10.** Close the side covers of the battery packs and the cover of the cable box.

5.3 Setting Common Parameters for the System

 In a parallel system, all settings must be the same for all inverters except for the addresses of the inverters.

When the energy storage system is powered on, on the LCD screen of the inverter, enter the **SETUP** page and set these common parameters:

- Step 1.** Set the working mode of the system. For more information, see the [WORK MODE](#) subsection under [SYS SETTING](#).
- Step 2.** Select the grid standard. For more information, see [GRID STD](#).
- Step 3.** Set the language of the integrated EMS. For more information, see [LANGUAGE](#).
- Step 4.** Set the date and time of the system. For more information, see [DATE/TIME](#).
- Step 5.** If external CTs are connected, run the CT self-check. For more information, see [CT SELF CHK](#).

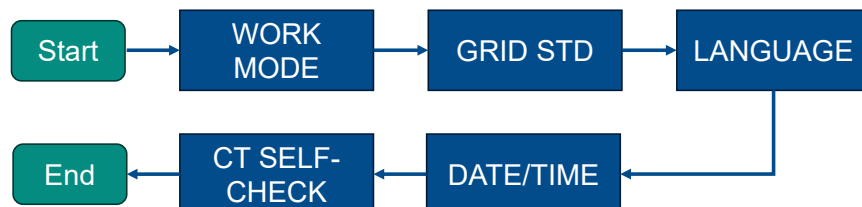

Figure 5-2 Set Common Parameters

If you want to set more parameters for the system, see [Setting up the System](#).

5.4 Checking the Settings

When the energy storage system is powered on, check the settings of the battery pack, PV, and grid to make sure that the system can work correctly.



To calibrate the SOC of the battery, after the system is installed, the batteries must be charged to 100% SOC once.

Step 1. Follow these steps to check the battery information:

- 1.1 Turn on the battery packs. For more information, see [Turning on a Battery Pack](#).



Make sure no red indicator light is ON.

- 1.2 Open the side covers of the battery packs and turn on the DC Switches.
- 1.3 Inside the cable box, turn on the Battery Switch.
- 1.4 5–10 seconds after the LCD screen on the inverter is turned on, check the information on the **BATTERY** page and the **BMS PARAM** page. For more information, see [Viewing the Current System Information](#).
 - Temperature: Depends on the ambient temperature around the system.
 - Voltage: Must be within the 50 V ± 3 V range.
 - Capacity: The capacity of a battery is 100 AH. When more than one battery pack is connected in parallel, the capacity of the system is 100 AH multiplied by the number of battery packs.

Step 2. After PV input is connected and the PV Switch inside the cable box is turned on, check the information on the **PV1 INPUT** and the **PV2 INPUT** page. For more information, see [Viewing the Current System Information](#).

Step 3. After ON GRID connection is done, check the information on the **GRID VOLT** page. For more information, see [Viewing the Current System Information](#).

5.5 Powering off

WARNING

To prevent damage or personal injury, after the equipment is turned off, DO NOT begin maintenance work until 5 minutes have passed.

- Step 1.** If backup loads are applied, turn off the LOAD Switch inside the cable box and the AC current breaker between the LOAD port and critical load.
- Step 2.** Inside the cable box, turn off the PV Switch and the Battery Switch.
- Step 3.** Open the side cover of the battery pack and turn off the DC Switch.
- Step 4.** Turn off the battery packs. For more information, see [Turning off a Battery Pack](#).
- Step 5.** In the distribution box, turn off the AC current breaker between ON GRID port and the grid.
- Step 6.** Close the side covers of the battery packs and the cover of the cable box.

6 System Operation

6.1 Restarting the System

If necessary, follow these steps to restart the system:

Step 1. Power off the system. For more information, see [Powering off](#).

Step 2. Power on the system. For more information, see [Powering On](#).

6.2 Viewing the Current System Information



Some parameter names shown on the integrated EMS page are abbreviated to fit the LCD display size.

Information shown on the screen is for reference only. It may vary depending on the software version.

When the inverter is ON, the LCD screen on the inverter automatically shows these pages, one after another:

- **DC VOLTAGE:** Shows the bus voltage.
- **BATTERY:** Shows the voltage, current, and capacity of the battery.
- **BMS PARAM:** Shows the battery type, temperature, SOC, charge voltage, charging current, and discharging current.
- **GRID VOLT, GRID CURR, GRID FREQ, INV VOLT, INV CURR, INV FREQ, BACKUP VOLT, and BACKUP CURR:** Shows the voltage of the R, S, and T phases.
- **POWER:** Shows the power of the inverters, the grid, the normal loads, the PV, the backup loads, and the battery.
- **TEMPERATURE:** Shows the temperature of the inverter, the DC-DC converter (DC/DC) inside the inverter, the environment, the PV, and the LLC circuit module.
- **STATE:** Shows the state of the system, the inverter circuit inside the inverter, and the DC-DC converter.

| Parameter Name | Value | Description |
|----------------|-------------|---|
| SYS | INIT | Means the system is being initialized. This state occurs when the system is being powered on and the ARM chip is not communicating with the DSP chip. |
| | Standby | Means the main power circuit is not ON. |
| | Hybrid-G | Means the system is being connected to the grid. |
| | Off-grid | Means the system is off grid. |
| | G-charge | Means the system is charged by the power grid. |
| | P-charge | Means the system is charged by the PV panels. |
| | G-bypass | Means the power grid is being bypassed. |
| | Error | Means an error has occurred. |
| INV | Standby | Means the inverter circuit is on standby. |
| | Off-grid | Means the inverter circuit is off grid. |
| | Para | Means the inverter is being connected to the grid. |
| | Off to para | Means the inverter is in transition from off-grid to on-grid. |
| | Para to off | Means the inverter is in transition from on-grid to off-grid. |
| DCDC | Standby | Means the DC-DC converter is on standby. |
| | Soft star | Means the DC-DC converter is in soft-start. |
| | Charge | Means the DC-DC converter is in charging mode. |
| | Discharge | Means the DC-DC converter is in discharging mode. |

- **ERROR NO.:** Shows the warning code and error code.
- **SYSTEM:** Shows the selected working mode, the selected grid standard, and the PV input mode.
- **PV1 INPUT:** Shows the input voltage, current, and power on the PV1 ports.
- **PV2 INPUT:** Shows the input voltage, current, and power on the PV2 ports.

6.3 Setting up the System









The inverter incorporates an energy management system (EMS). You can use the LCD screen on the inverter to operate the integrated EMS to set the parameters. For more information about the buttons on the inverter, see [LCD Screen](#).



Information shown on the screen is for reference only. It may vary depending on the software version.

6.3.1 Go to SETUP

Follow these steps to go to the **SETUP** page to set or view the parameters:

- Step 1.** When the LCD screen on the inverter shows different information items one after another, press  to go to the **USER** page.
- Step 2.** On the **USER** page, press  or  to move the cursor to **SETUP** and then press .
- Step 3.** On the **PASSWORD** page, enter your password by pressing  or  to change the digits.
For the first log-in, use the default password **00000**. To change the password, see [PASSWORD](#).
- Step 4.** On the **SETUP** page, press  or  to move the cursor and then press  to select a parameter group to set:
- **SYS SETTING:** To set the configuration of the system. See [SYS SETTING](#).
 - **BAT SETTING:** To set the configuration of the batteries. See [BAT SETTING](#).
 - **GRID STD:** To select a grid standard. See [GRID STD](#).
 - **RUN SETTING:** To set the configuration to run the system. See [RUN SETTING](#).
 - **485 ADDRESS:** To set the parameters for RS485 communication. See [RS485 ADDRESS](#).
 - **BAUD RATE:** To set baud rate for data transmission. See [BAUD RATE](#).
 - **LANGUAGE:** To set the language of the integrated EMS. See [LANGUAGE](#).
 - **BACK LIGHT:** To set the duration before the screen backlight automatically turns off. See [BACK LIGHT](#).
 - **DATE/TIME:** To set the date and time shown on the system. See [DATE/TIME](#).
 - **CLEAR REC:** To clear the records. See [CLEAR REC](#).
 - **PASSWORD:** To change the password. See [PASSWORD](#).
 - **MAINTENANCE:** For maintenance personnel only. See [MAINTENANCE](#).
 - **AUTO TEST:** To run an automatic test. Only applicable in Italy. See [AUTO TEST](#).
 - **OPERAT MODE:** Only applicable in Italy. See [OPERAT MODE](#).
 - **CT SELF CHK:** To run a CT self-check. See [CT SELF CHK](#).
 - **AFCI TEST:** To run a forced AFCI test. See [AFCI TEST](#).

When the settings are done, you can press  to leave the current setting page.

6.3.2 SYS SETTING

On the **SETUP** page, press \uparrow or \downarrow to move the cursor to select **SYS SETTING** and then press \leftarrow to view and set parameters of the system.

WORK MODE

On the **SYS SETTING** page, press \uparrow or \downarrow to move the cursor to select **WORK MODE** and press \leftarrow to set a working mode.

The E8KT/E10KT/E12KT supports three working modes: SELF CONSUME, PEAK SHIFT, and BAT PRIORITY. For more information, see [Working Modes](#).

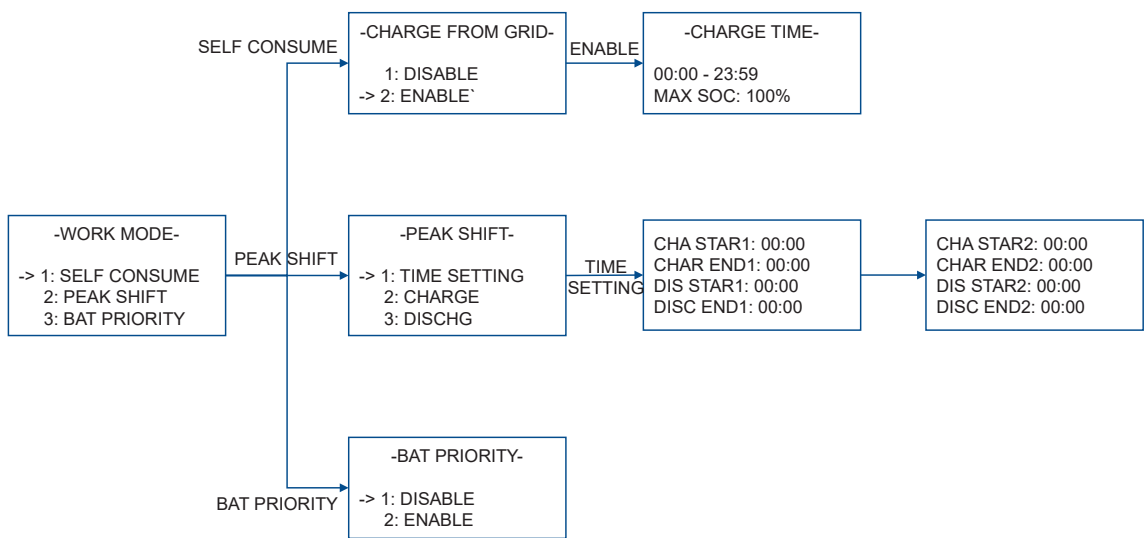



- **SELF CONSUME:** This is the default working mode. In this mode, the batteries are charged by the PV panel by default.

On the **WORK MODE** page, press \uparrow or \downarrow to move the cursor to select **SELF CONSUME** and then press \leftarrow . On the **CHARGE FROM GRID** page, you can enable the batteries to be charged by the grid. When **CHARGE FROM GRID** is enabled, you can set the time and the maximum SOC for charging. Charging will automatically stop when the set time or **MAX SOC** is reached.

- **PEAK SHIFT:** On the **WORK MODE** page, press \uparrow or \downarrow to move the cursor to select **PEAK SHIFT** and then press \leftarrow . On the **PEAK SHIFT** page, you can set times for charging and discharging (up to two each), and then press \uparrow or \downarrow to move the cursor to select **CHARGE** or **DISCHR** to charge or discharge the battery. During the charging time, the batteries are forced to be charged by the grid and/or the PV panels. During the discharging time, the batteries are forced to be discharged to the connected load.
- **BAT PRIORITY:** To enable this mode, go to the **WORK MODE** page and press \uparrow or \downarrow to move the cursor to select **BAT PRIORITY**, and then press \leftarrow .

PV INPUT

There are two modes for PV inputs: independent and parallel. Set the appropriate PV input mode based on the actual connection of the PV strings.

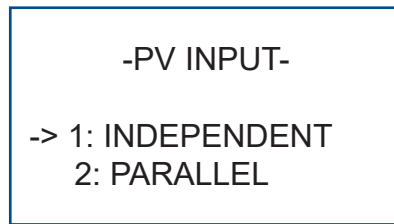

On the **SYS SETTING** page, press  or  to move the cursor to select **PV INPUT** and press  for settings.

The default setting is **INDEPENDENT**. If independent mode is selected when the PV strings are actually connected in parallel, it results in an imbalanced distribution of power in the PV strings.



ZERO EXPORT

The E8KT/E10KT/E12KT can output power to the grid.

On the **SYS SETTING** page, press  or  to move the cursor to select **ZERO EXPORT** and press .

By default, this feature is disabled. When the feature is enabled, the system outputs power to the grid and you can set the power limit in the range from 10 W to the rated power of the system.

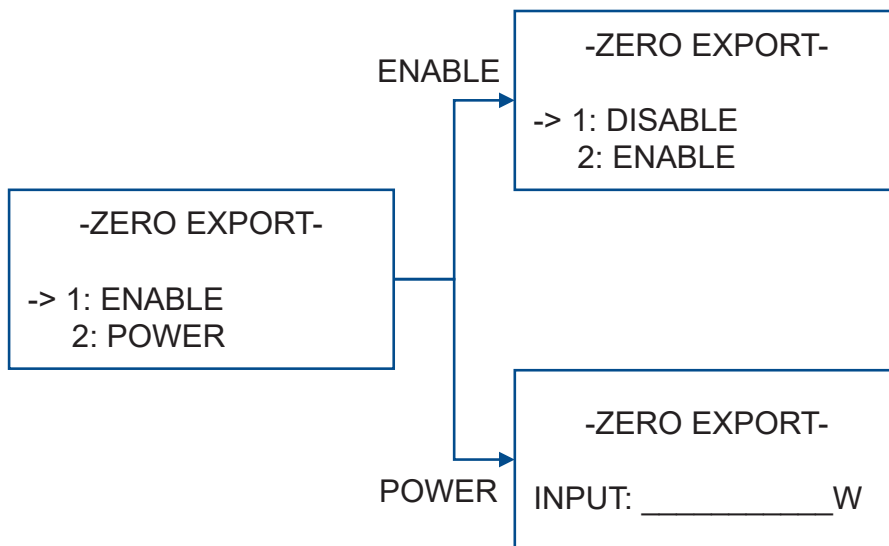

DRM ENABLE



The E8KT/E10KT/E12KT supports DRM.

On the **SYS SETTING** page, press  or  to move the cursor to select **DRM ENABLE** and press .

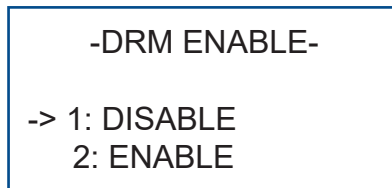
By default, this feature is disabled. In the countries where DRM is mandatory, enable the DRM feature. When the DRM connection is done, you must set **DRM ENABLE** to **ENABLE**. For more information about DRED connection, see [\(Optional\) Connecting a DRED or an RRCR](#).



EPS ENABLE

On the **SYS SETTING** page, press  or  to move the cursor to select **EPS ENABLE** and press .

By default, the E8KT/E10KT/E12KT can automatically switch to backup power when a grid power failure occurs.

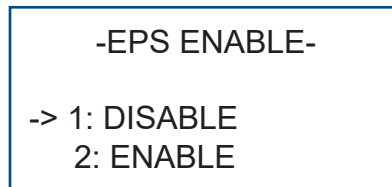

REMOTE CTRL

You can control the system through RS485 communication.



On the **SYS SETTING** page, press  or  to move the cursor to select **REMOTE CTRL** and press .

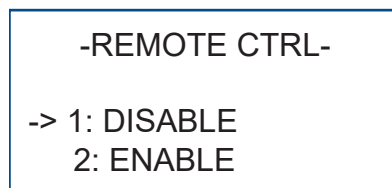

By default, this feature is disabled.



START DELAY

By default, when power is supplied to the inverter, there is a 30-second delay before the inverter starts.

On the **SYS SETTING** page, press  or  to move the cursor to select **START DELAY** and press  to change the delay time.

You can press  or  to increase or decrease the delay time in the range of 20–300 seconds. See [GRID STD](#) for the start delay time for the selected grid standard.

-START DELAY-

INPUT: _____



UNIT: SEC

CEI SPI CTRL

The E8KT/E10KT/E12KT supports the CEI 0:21 standard. Currently, this feature is applicable in Italy only.

When Italy is selected as the grid standard, you can select OPERAT MODE through the setting of CEI SPI CTRL and the states of PIN1 and PIN7 of the DRM port:

- When PIN1 and PIN7 are not shorted and CEI SPI CTRL is disabled, **Transient** is enabled for OPERAT MODE.
- When PIN1 and PIN7 are shorted and CEI SPI CTRL is enabled, **Final** is enabled for OPERAT MODE.

On the **SYS SETTING** page, press  or  to move the cursor to select **CEI SPI CTRL** and press .

By default, this feature is disabled.

-CEI SPI CTRL-

-> 1: DISABLE

2: ENABLE

GFCICHK ENB

The E8KT/E10KT/E12KT supports a connection of ground failure circuit interrupter to monitor the AC grid connection.

On the **SYS SETTING** page, press  or  to move the cursor to select **GFCICHK ENB** and press .



By default, this feature is enabled.

-GFCICLK ENB-

-> 1: DISABLE
2: ENABLE

DOD ENABLE

DOD means Depth of Discharge. Enabling DOD can prevent the battery from discharging to 0%.

On the **SYS SETTING** page, press  or  to move the cursor to select **DOD ENABLE** and press .

By default, DOD is enabled.





Disabling DOD is not recommended.

-DISCHG DEPTH-

-> 1: DISABLE
2: ENABLE

GENERATOR

You can use a generator, for example, a wind generator or a diesel generator, as a backup supply to the E8KT/E10KT/E12KT energy storage system.

On the **SYS SETTING** page, press  or  to move the cursor to select **GENERATOR** and press  to enable the generator mode.



By default, this feature is disabled. When the grid power is not available, you can manually enable the generator mode and connect the load to the generator.

-GENERATOR-

-> 1: DISABLE
2: ENABLE

CT OR METER

The E8KT/E10KT/E12KT support connecting external CTs or a smart meter for measuring the energy consumption.

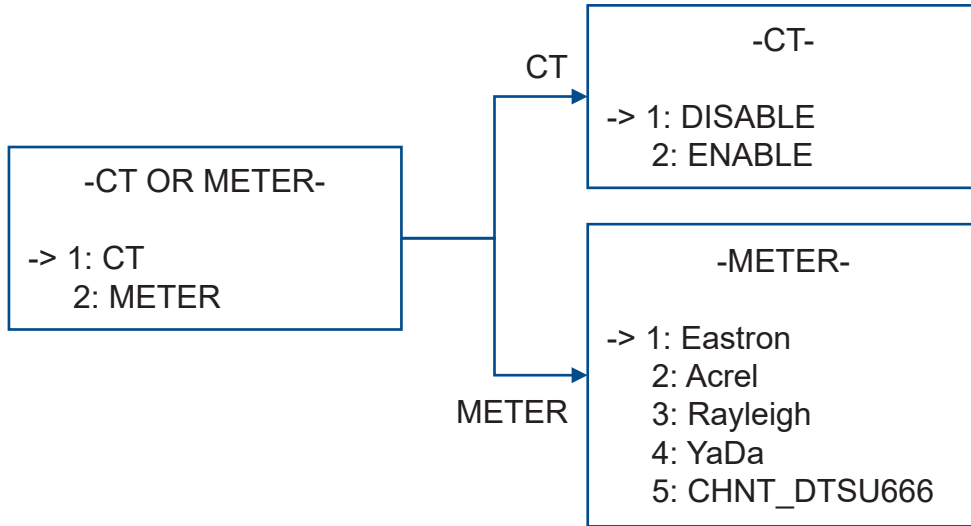

On the **SYS SETTING** page, press  or  to move the cursor to select **CT OR METER** and press .

By default, **CT** is selected. If you want to connect a smart meter, five brands are supported currently. The Eastron SDM630MCT-40mA is recommended.



AC COUPLE

If you want to connect an inverter to your PV panels to build an AC-coupling system, you must enable **AC COUPLE**.

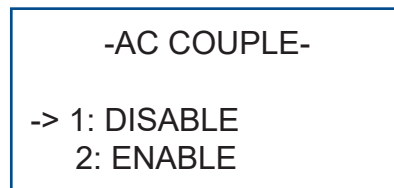

On the **SYS SETTING** page, press  or  to move the cursor to select **AC COUPLE** and press .

By default, this feature is disabled. For more information, see [AC-coupling System](#).



PARALLEL

When more than one inverter is installed in parallel, you must enable **PARALLEL** and set the addresses for the inverters.

On the **SYS SETTING** page, press  or  to move the cursor to select **PARALLEL** and press .

When a parallel system is installed and **PARALLEL** is enabled, assign an address (a value from 1 to 4) to each inverter. The address of the primary inverter must be set to 1. A maximum of four inverters are supported. For more information, see [Installing a Parallel System](#).

By default, this feature is disabled.

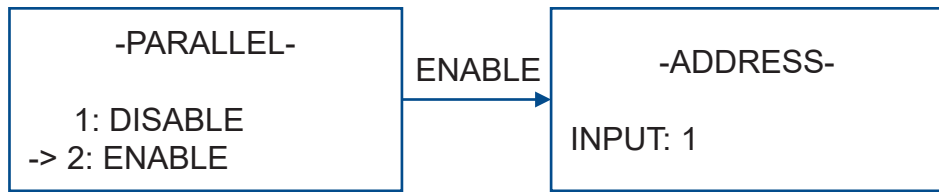

AFCI

The E8KT/E10KT/E12KT has an AFCI protection feature.

On the **SYS SETTING** page, press or to move the cursor to select **AFCI** and press .

By default, this feature is disabled. When it is enabled, dangerous arcing faults on the PV panels can be detected. You can set the detection level for AFCI protection to a value from **1** to **9**. The lower the value, the lower the AFCI threshold.

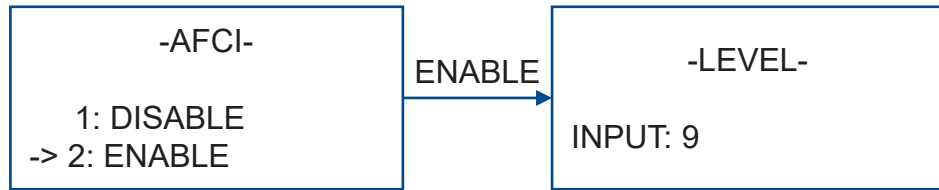

SILENT MODE

The E8KT/E10KT/E12KT can be set to silent mode. In silent mode, the fan speed is reduced and the inverter produces less noise.

On the **SYS SETTING** page, press or to move the cursor to select **SILENT MODE** and press .

By default, this mode is enabled.

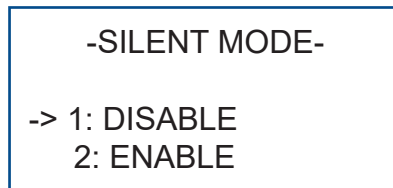

CYBERSAFETY



Currently, this feature is applicable in UK only.

The E8KT/E10KT/E12KT supports remote control of the inverter.

On the **SYS SETTING** page, press  or  to move the cursor to select **CYBERSAFETY** and press .

On the **CYBERSAFETY** page, you have two options:

- **Modbus Write:** To enable or disable remote control of the inverter. When this feature is enabled, you can control the inverter on the data-monitoring page.
- **Upgrade:** When this feature is enabled, you can upgrade the firmware of the inverter or the battery packs remotely.

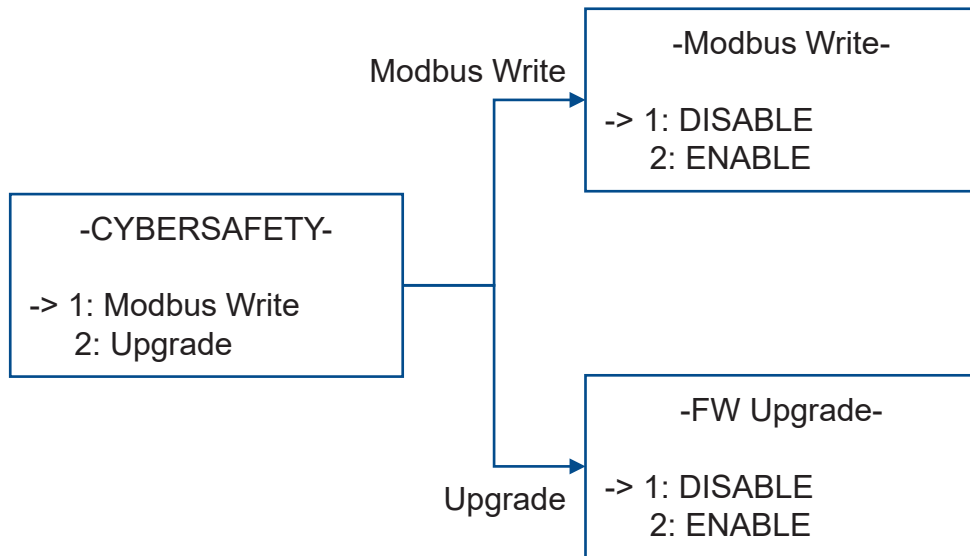

GRID TYPE



The E8KT/E10KT/E12KT provides two grid-connected power output modes:

- **Mixed Mode:** When the inverter is connected to the grid, the three phases output the same power.
- **Independent:** When the inverter is connected to the grid, the three phases can output different power.

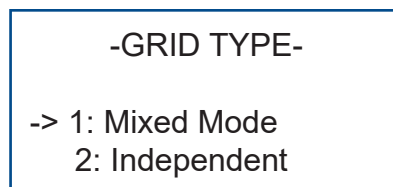

You can select the appropriate grid-connected power output mode in the integrated EMS: On the **SYS SETTING** page, press  or  to move the cursor to select **GRID TYPE** and press .



6.3.3 BAT SETTING

On the **SETUP** page, press  or  to move the cursor to select **BAT SETTING** and then press  to view and set the configurations of the batteries.

BAT TYPE

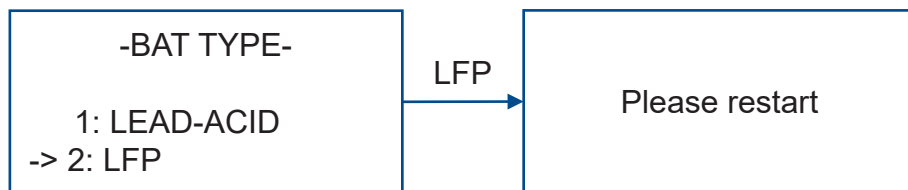

On the **BAT SETTING** page, press  or  to move the cursor to select **BAT TYPE**, and press .

Currently, only **LFP** batteries are supported. After selecting **LFP**, you must restart the system. For more information, see [Restarting the System](#).



DISC DEPTH

When the E8KT/E10KT/E12KT energy storage system is connected to the power grid, you can set the maximum depth of discharge of batteries.

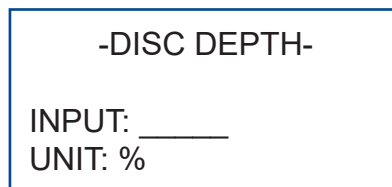

On the **BAT SETTING** page, press  or  to move the cursor to select **DISC DEPTH**, and press .

The range for this parameter is 10–95%, and the default value is **90%**.



CHG CURR

You can set the maximum battery charging current.

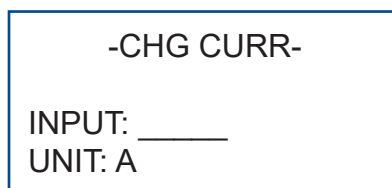

On the **BAT SETTING** page, press  or  to move the cursor to select **CHG CURR**, and press .

The range for this parameter is 1–160 A. The default value is **160 A**.



DISC POWER

You can set a maximum discharge power, expressed as a percentage of the rated output power.

On the **BAT SETTING** page, press  or  to move the cursor to select **DISC POWER**, and press .

The range for this parameter is 0–100%. The default value is **100%**.

-DISC PERCENT-

INPUT: ____%

CHG POWER

You can set a maximum charge power, expressed as a percentage of the rated output power.

On the **BAT SETTING** page, press  or  to move the cursor to select **CHG POWER**, and press .



The range for this parameter is 1–100%. The default value is **100%**.

-CHAR PERCENT-

INPUT: ____%

BAT END VOLT

You can set a voltage as the end-of-discharge voltage. During discharging, when the set end-of-discharge voltage is reached, it means 0% of voltage has been reached and discharging is stopped.

On the **BAT SETTING** page, press  or  to move the cursor to select **BAT END VOLT**, and press .

The range for this parameter is 40–48 V. The default value is **43.2 V**.

-BAT END VOLT-

INPUT: _____



UNIT: V





BAT WAKE-UP

The battery will go to sleep in these states:

- Over-discharge protection.
- No communication between the battery and the external and no charging or discharging current for a period.

By default, the system monitors the SOC and DOD of the batteries. You can set the system to wake up the batteries from sleep and to check the SOC and DOD at a set interval.

On the **BAT SETTING** page, press  or  to move the cursor to select **BAT WAKE-UP** and press .

When the wake-up feature is enabled, on the **BAT WAKE-UP** page, press  or  to move the cursor to select **TIME**, press , and then press  or  to change the interval. The range for this parameter is 0–300 minutes.

You can disable the wake-up feature.

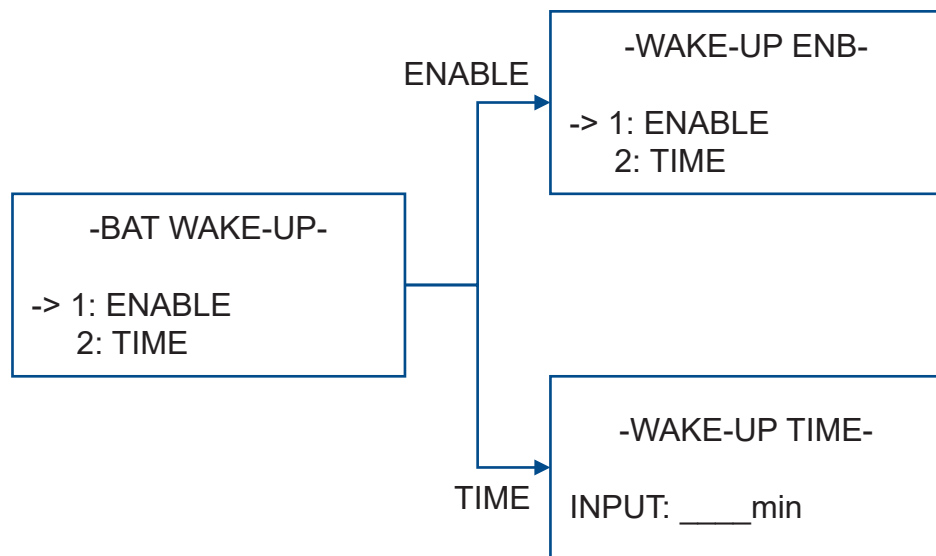

HEATING FILM



Only applicable to the batteries with heating films.
This feature is not applicable to BluE-PACK5.1.



If you ordered and installed a heating film for the battery pack, you can decide whether to enable the heating film or not.

On the **BAT SETTING** page, press  or  to move the cursor to select **HEATING FILM** and press .

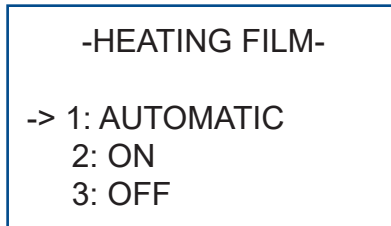
By default, the setting is **AUTOMATIC**. It means the film is automatically turned on or off based on the ambient temperature.



BMS DOD

On the **BAT SETTING** page, press  or  to move the cursor to select **BMS DOD** and press .

By default, BMS depth of discharge is disabled, and the inverter monitors the depth of discharge of the battery. Generally, DO NOT enable BMS DOD.

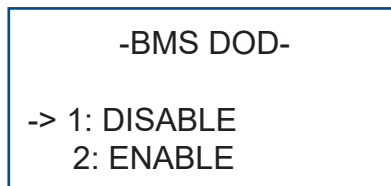

MAINTAIN SOC

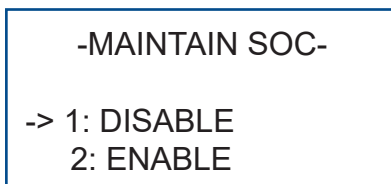

On the **BAT SETTING** page, press  or  to move the cursor to select **MAINTAIN SOC** and press .

When MAINTAIN SOC is enabled, the minimum battery SOC is maintained. The minimum battery SOC is 2%. When the battery SOC is less than 2%, the grid charges the battery to 5% through the inverter.





FORCE WAKE

By default, a battery goes to sleep and is woken up at a set interval, but if you enable the **FORCE WAKE** feature, the battery will stay online and not go to sleep.

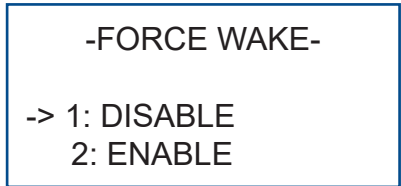
On the **BAT SETTING** page, press  or  to move the cursor to select **FORCE WAKE** and press .



6.3.4 GRID STD

On the **SETUP** page, press  or  to select **GRID STD** to select the grid standard that is applicable to your energy storage system. The default value is Local.





Local is a customized grid standard that specifies the widest output voltage range and output frequency range. It is applicable to most energy storage systems.

Table 6-1 lists the specifications of different grid standards.

Table 6-1 Grid Specifications

| | Grid | Output Voltage Range (VAC) | Output Frequency Range (Hz) | Start Delay (s) |
|--------------------|--------------|-----------------------------------|------------------------------------|------------------------|
| 1 | China | 187–252 | 49.5–50.2 | 30 |
| 2 | Germany | 184–264 | 47.5–51.5 | 60 |
| 3 Australia | AUS-A | 180–265 | 47–52 | 60 |
| | AUS-B | 180–265 | 47–52 | 60 |
| | AUS-C | 180–265 | 45–55 | 60 |
| 4 Italy | CEI0-21 | 195–264 | 49.8–50.2 | 60 |
| | CEI0-21 ACEA | 195–264 | 49.8–50.2 | 60 |
| 5 | Spain | 196–253 | 48–50.5 | 180 |
| 6 | U.K. | 184–264 | 47–52 | 180 |
| 7 | Hungary | 196–253 | 49–51 | 300 |
| 8 | Belgium | 184–264 | 47.5–51.5 | 60 |
| 9 | New Zealand | 180–260 | 45–52 | 60 |
| 10 | Greece | 184–264 | 49.5–50.5 | 180 |
| 11 | France | 184–264 | 47.5–50.4 | 60 |
| 12 | Bangkok | 198–242 | 49–51 | 150 |
| 13 | Thailand | 198–242 | 47–52 | 60 |
| 14 | South Africa | 180–260 | 47.0–52 | 60 |
| 15 | 50549 | 184–264 | 47.5–51.5 | 60 |
| 16 | Brazil | 184–264 | 59.5–60.5 | 60 |
| 17 | 0126 | 184–264 | 47.5–51.5 | 60 |
| 18 | Ireland | 184–264 | 47–52 | 180 |
| 19 | Israel | 195.5–253 | 47.0–51.5 | 60 |
| 20 | Poland | 195.5–253 | 49.00–50.05 | 60 |
| 21 Chile | Chile-BT | 176.0–242 | 47.5–51.5 | 60 |
| | Chile-HD | 198.0–242 | 49–51 | 300 |
| | Chile-LD | 198.0–242 | 49–51 | 300 |
| 22 | Local | 150–280 | 45.0–55 | 30 |
| 23 | 60Hz | 184–264 | 59.5–60.5 | 60 |
| 24 | Denmark | 195.5–253.0 | 47.5–51.5 | 60 |
| 25 | Sweden | 195.5–253.0 | 47.5–51.5 | 60 |
| 26 | Austria | 184–264.5 | 47.5–51.5 | 300 |

6.3.5 RUN SETTING

On the **SETUP** page, press  or  to move the cursor to select **RUN SETTING** and then press  to view and set parameters the configurations to run the system.

REACT MODE

The E8KT/E10KT/E12KT provide some ways to monitor reactive power. These settings are determined by the selected grid standard. You must not change these settings during system operation.

On the **RUN SETTING** page, press  or  to move the cursor to select **REACT MODE** and press .

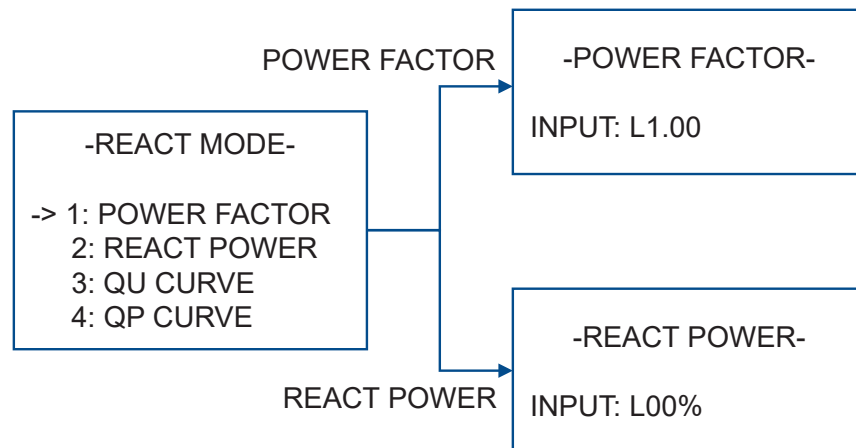

Here are the settings:

- **POWER FACTOR:** The acceptable range is L0.8–L1.00 and C0.8–C1.00. The default setting is PF1.0.
- **REACT POWER:** The acceptable range is L00%–L60% and C00%–C60%.
- **QU CURVE** and **QP CURVE:** By default, both are disabled.



GRID POWER

You can limit or increase the power output from the system to the grid.

On the **RUN SETTING** page, press  or  to move the cursor to select **GRID POWER** and press .

The setting value is a percentage of the rated power of the system. It can be set from 0% to 100%, and the default value is **100%**.

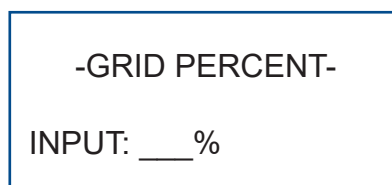

GRID U and GRID F

Table 6-2 lists the inverter parameters for **RUN SETTING**.

On the **RUN SETTING** page, press or to move the cursor to select **GRID U MAX**, **GRID U MIN**, **GRID F MAX**, or **GRID F MIN** and press .

When you select the grid standard in GRID STD, these parameters are set automatically. During operation, when the inverter detects that these settings have been reached or exceeded, the inverter stops generating power.





Changing the setting of these parameters is not recommended. After adjusting one or more parameters, follow the onscreen prompts and restart the system. For more information, see [Restarting the System](#).

Table 6-2 GRID Parameters for Run Setting

| Parameter | | Description | Default |
|-------------------|-----------|-----------------------|---------|
| GRID U MAX | VOLT (S1) | Upper limit voltage | 280 VAC |
| | | Protection time | 1000 ms |
| | VOLT (S2) | Upper limit voltage | 285 VAC |
| | | Protection time | 400 ms |
| GRID U MIN | VOLT (S1) | Lower limit voltage | 150 VAC |
| | | Protection time | 1000 ms |
| | VOLT (S2) | Lower limit voltage | 120 VAC |
| | | Protection time | 400 ms |
| GRID F MAX | FREQ (S1) | Upper limit frequency | 55 Hz |
| | | Protection time | 500 ms |
| | FREQ (S2) | Upper limit frequency | 55 Hz |
| | | Protection time | 500 ms |
| GRID F MIN | FREQ (S1) | Lower limit frequency | 45 Hz |
| | | Protection time | 500 ms |
| | FREQ (S2) | Lower limit frequency | 45 Hz |
| | | Protection time | 500 ms |

BYPASS U and BYPASS F

Table 6-3 lists the grid bypass parameters for **RUN SETTING**.

On the **RUN SETTING** page, press  or  to move the cursor to select **BYPASS U MAX**, **BYPASS U MIN**, **BYPASS F MAX**, or **BYPASS F MIN** and press .

When the inverter is in grid bypass output state:

- When the grid voltage is in the range from **BYPASS U MIN** to **BYPASS U MAX**, or the grid frequency is in the range from **BYPASS F MIN** to **BYPASS F MAX**, the backup voltage is equal to the grid voltage.
- When the grid voltage is higher than **BYPASS U MAX** or lower than **BYPASS U MIN**, or the grid frequency is higher than the **BYPASS F MAX** or lower than **BYPASS F MIN**, the backup load turns off the output. This means the backup voltage is 0 V.

When you select the grid standard in **GRID STD**, these parameters are set automatically. During operation, when the inverter detects that these settings have been reached or exceeded, the inverter stops generating power.





Changing the setting of these parameters is not recommended. After adjusting one or more parameters, follow the onscreen prompts and restart the system. For more information, see [Restarting the System](#).

Table 6-3 BYPASS Parameters for Run Setting

| Parameter | Description | Default |
|---------------------|-------------------------------|---------|
| BYPASS U MAX | Maximum voltage of the grid | 280 VAC |
| BYPASS U MIN | Minimum voltage of the grid | 130 VAC |
| BYPASS F MAX | Maximum frequency of the grid | 55 Hz |
| BYPASS F MIN | Minimum frequency of the grid | 45 Hz |

OVER VOLT and UNDER VOLT

On the **RUN SETTING** page, press  or  to move the cursor to select **OVER VOLT** or **UNDER VOLT** and press .

When you select the grid standard in **GRID STD**, these parameters are set automatically.



Changing the settings of these parameters is not recommended.
After adjusting one or more parameters, you must restart the system. For more information, see [Restarting the System](#).

By default, **OVER VOLT** and **UNDER VOLT** are disabled. You can enable them and set the voltages:

- **OVER VOLT**: When it is enabled, you can set **VOLT**. If the AC output voltage is higher than the set value, the output power decreases. The default value of **VOLT** is 270 V. You can press or to increase or decrease the value.
- **UNDER VOLT**: When it is enabled, you can set **VOLT**. If the AC output voltage is lower than the set value, the output power decreases. The default value of **VOLT** is 200 V. You can press or to increase or decrease the value.

OVER FREQ and UNDER FREQ

On the **RUN SETTING** page, press or to move the cursor to select **OVER FREQ** or **UNDER FREQ** and press .

When you select the grid standard in **GRID STD**, these parameters are set automatically.



Changing the setting of these parameters is not recommended.
After adjusting one or more parameters, you must restart the system. For more information, see [Restarting the System](#).



By default, **OVER FREQ** and **UNDER FREQ** are disabled. You can enable them and set the frequencies:

- **OVER FREQ**: When it is enabled, you can set **FREQ**. If the AC output frequency is higher than the set value, the output power decreases. The default value of **FREQ** is 52 Hz. You can press or to increase or decrease the value.
- **UNDER FREQ**: When it is enabled, you can set **FREQ**. If the AC output frequency is lower than the set value, the output power decreases. The default value of **FREQ** is 48 Hz. You can press or to increase or decrease the value.

REACT RESP

On the **RUN SETTING** page, press  or  to move the cursor to select **REACT RESP** and press .

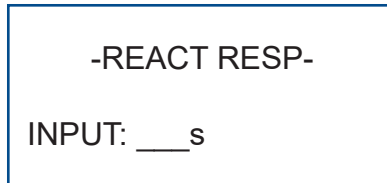

REACT RESP allows you to set the necessary time for the output reactive power to reach the grid standard level. The selected grid standard determines the time, so **DO NOT** change it if the grid is not changed. The default value is 10 seconds.

You can press  or  to increase or decrease the value in the range of 6–60 seconds.



VRT ENABLE

VRT ENABLE is to enable or disable voltage-ride-through.

On the **RUN SETTING** page, press  or  to move the cursor to select **VRT ENABLE** and press .



When you select the grid standard in **GRID STD**, **VRT ENABLE** is set automatically.



Changing the setting of **VRT ENABLE** is not recommended.

POW SI RATE

POW SI RATE means the change of output power per minute.



On the **RUN SETTING** page, press  or  to move the cursor to select **POW SI RATE** and press .

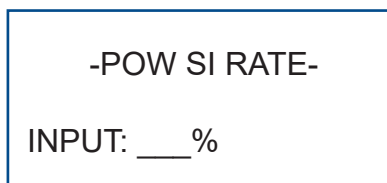

The selected grid standard determines the rate, so **DO NOT** change it if the grid is not changed. The value of 100% means that the output power can reach the rated power within one minute. The range for this parameter is 0% to 300%, and the default value is **100%**.





PV START

You can set the PV start voltage.

On the **RUN SETTING** page, press  or  to move the cursor to select **PV START** and press .

The default value is 350 V, and you can press  or  to increase or decrease the value in the range from 200 V to 350 V.

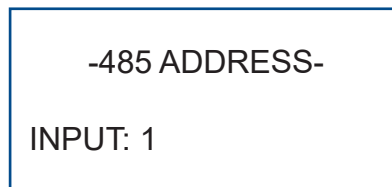

6.3.6 RS485 ADDRESS

On the **SETUP** page, press  or  to select **RS485 ADDRESS** to set the RS485 address for the COM port. By default, the address is 1, and you can set it to any value from 1 to 32.





6.3.7 BAUD RATE

Obtain the baud rate of the COM port of the upper computer and set the same baud rate for the COM port of the inverter.

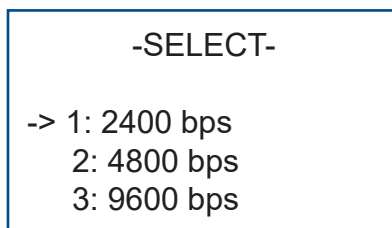
On the **SETUP** page, press  or  to select **BAUD RATE** to set the baud rate of the RS485 communication for the COM port. It can be set to 2400 bps, 4800 bps, or 9600 bps. The default value is 9600 bps.



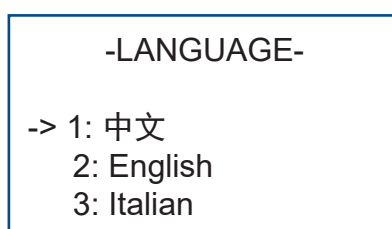

6.3.8 LANGUAGE

On the **SETUP** page, press  or  to select **LANGUAGE** to set the display language. By default, the language is English and you can change it to 中文 (Chinese) or Italian.



6.3.9 BACK LIGHT

On the **SETUP** page, press  or  to select **BACK LIGHT** to set how long the backlight stays on at a time. By default, the backlight stays on for 20 seconds at a time. The range for this parameter is 20–120 seconds.

When the backlight is off, press any button to turn it on.

-LIGHT TIME-

INPUT: _____

UNIT: SEC

6.3.10 DATE/TIME

On the **SETUP** page, press  or  to select **DATE/TIME** to set the date, time, and day of the week for the system.



-DATE/TIME-

DATE: YYYY-MM-DD

TIME: hh:mm:ss

WEEK: SUNDAY

6.3.11 CLEAR REC

On the **SETUP** page, press  or  to select **CLEAR REC** to clear all records. After the records are cleared, you cannot find any information in **INQUIRE**. For more information about records, see [Viewing INQUIRE](#).

-DEL REC-

-> 1: CANCEL

2: CONFIRM









6.3.12 PASSWORD



It is recommended that you change the password immediately after the installation.

On the **SETUP** page, press  or  to select **PASSWORD** to change the password.

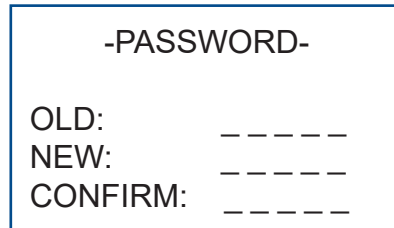

Follow these steps:

- Step 1.** On the **SETUP** page, press  or  to select **PASSWORD**.
- Step 2.** On the **OLD** row of the **PASSWORD** page, press  or  to change the digits to the old password. The default password is **00000**.
- Step 3.** On the **NEW** row of the **PASSWORD** page, press  or  to change the digits to a new password.
- Step 4.** On the **CONFIRM** row of the **PASSWORD** page, press  or  to change the digits to the new password again to confirm the change.



6.3.13 MAINTENANCE

MAINTENANCE is for use by maintenance personnel only.

On the **SETUP** page, press  or  to select **MAINTENANCE** and press .

On the **MAINTAIN** page, three options are available:

- **CLEAR ENERGY:** To clear data.
- **AGEING:** This feature is inaccessible.
- **ISLAND:** To enable anti-islanding protection. This is for use by maintenance personnel only.





6.3.14 AUTO TEST

In Italy, when an E8KT/E10KT/E12KT energy storage system is installed, it must pass the **AUTO TEST** in the specified operate mode before being connected to the local grid. For more information about the operate mode, see [OPERAT MODE](#).



AUTO TEST is only applicable in Italy.

When an operate mode is specified, follow these steps to run the **AUTO TEST**:

- Step 1.** On the **SETUP** page, press  or  to select **AUTO TEST**.
- Step 2.** Use  or  to enter your password. The default password is **00000**. If you have changed the password, use the new password. If the password is correct, a countdown page is shown on the screen. When the countdown ends, the automatic test starts. When the automatic test ends, Pass or Fail is shown. If the result is Fail, run the automatic test again. If you run the test multiple times and the result is always Fail, contact KSTAR New Energy.

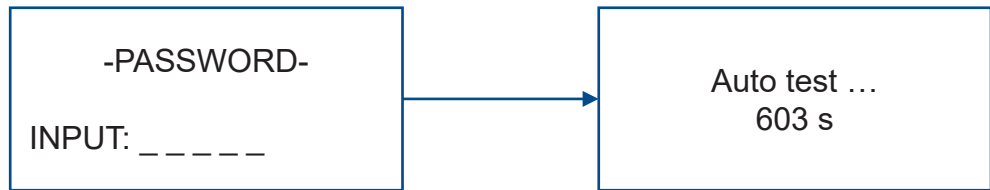

6.3.15 OPERAT MODE



This feature is only applicable in Italy.

Two mode options are available: Transient and Final. These modes differ in the duration of under-frequency protection of the second stage and the duration of the over-frequency protection of the second stage. The Final mode has a longer protection duration.

Mode selection is determined by the states of PIN1 and PIN7 of the DRM port and the setting of **CEI SPI CTRL**. For more information, see the [CEI SPI CTRL](#) subsection under [SYS SETTING](#).

On the **SETUP** page, press  or  to select **OPERAT MODE** and press .

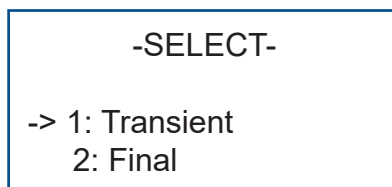

6.3.16 CT SELF CHK

When three external CTs are connected to the inverter, you can run a CT self-check. A CT self-check lasts 1–5 minutes.

Before running a CT self-check, make sure that all these operations are done:

Step 1. Connect external CTs. For more information, see [Connecting External CTs](#).

Step 2. Connect the inverter to the battery packs and the power grid.

On the **SETUP** page, press  or  to select **CT SELF CHK** and press .



These errors can occur during a CT self-check:

- **battery loss, fail to check:** Means no battery packs are connected to the system, so the CT self-check cannot be completed. You must connect battery packs and try the CT self-check again.
- **grid loss, fail to check:** Means the system is not connected to the grid, so the CT self-check cannot be completed. You must connect the system to the grid and try the CT self-check again.
- **CT loss, fail to check:** Means no external CTs are connected to the system, so the CT self-check cannot be completed. You must connect external CTs to the system and try the CT self-check again.
- **Timeout, fail to check:** Means the CT self-check timeout. Make sure that limits have not been placed on the charging and discharging power, because the power on each phase of the grid must be greater than 1 kW during a CT self-check. To achieve this, **DISC POWER**, **CHG POWER**, and **GRID POWER** must be set to **100%** and **CHG CURR** must be set to 160 A. For more information, see the [DISC POWER](#), [CHG POWER](#), and [CHG CURR](#) subsections under [BAT SETTING](#), and the [GRID POWER](#) subsection under [RUN SETTING](#).

6.3.17 AFCI TEST

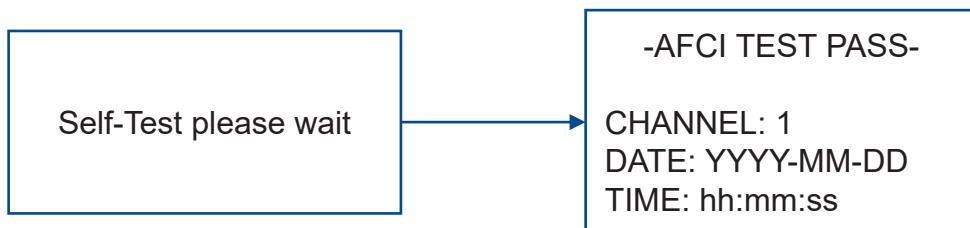

The E8KT/E10KT/E12KT can conduct an AFCI test.

On the **SETUP** page, press  or  to select **AFCI TEST** and press . The self-test starts automatically.



6.4 Viewing INQUIRE

You can view the information of the E8KT/E10KT/E12KT energy storage system.

On the **USER** page, press  or  to select **INQUIRE** to view this information:

- **INV MODEL:** The model of the hybrid inverter in use.
- **MODEL SN:** The serial number of the hybrid inverter in use.
- **FIRMWARE:** The version of the firmware in ARM, DSP, and DSP2.
- **RECORD:** The errors of the system. You can view the last 500 errors. The earliest errors are automatically overwritten when more than 500 errors occur.
- **BMS INFO:** The information and the states of the connected battery packs, including:
 - **VERSION:** The version of the BMS.
 - **CYCLE CNT:** The number of battery cycles.
 - **PROTECT, WARN CODE, and FAULT CODE:** The codes sent by the BMS to the inverter. You should contact Customer Service for more information about these codes.
- **METER STATUS:** The communication state of the energy meter.
- **PARALLEL:** The states of the inverters and loads in a parallel system, including:
 - **INVERTERx: OFFLINE or ONLINE.** When an inverter is connected in a parallel system and its PARALLEL feature is enabled, the inverter is **ONLINE**. Otherwise, the inverter is **OFFLINE**. For more information, see [Installing a Parallel System](#).
 - **INVERTERx: INIT, Standby, Hybrid-G, Off-grid, G-charge, P-charge, G-bypass, or Error.** This shows the values of the SYS parameter shown on the **STATE** page on the LCD screen of the inverter with address x. For more information, see [Viewing the Current System Information](#).
- **INV-x:Ex:** The inverted power of the inverter with the address x.
- **Load-x:** The load power of the inverter with the address x.

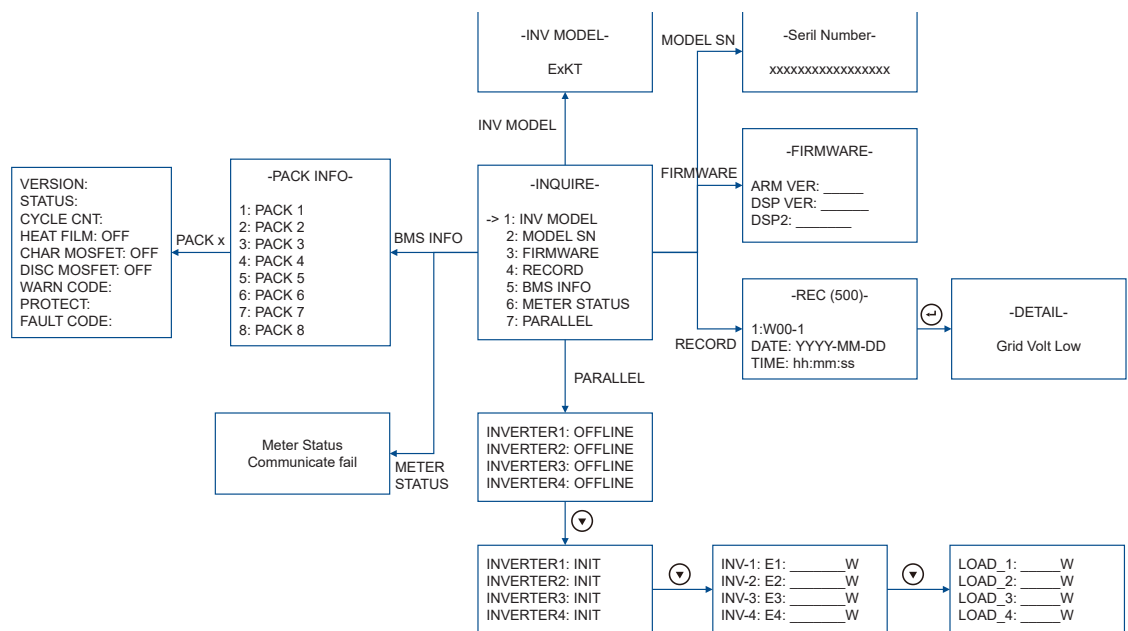

Figure 6-1 INQUIRE

6.5 Viewing STATISTIC

You can view some data of the E8KT/E10KT/E12KT energy storage system.

On the **USER** page, press **▲** or **▼** to select **STATISTIC** to view this information:

- **TIME STAT:** Hours of the inverter running and its connection to the grid.
- **CONNE. TIMES:** Number of inverter connections to the grid.
- **PEAK POWER:** Total generation of watts and today's generation of watts.
- **E-TODAY, E-MONTH, E-YEAR, and E-TOTAL:** The electricity generation for the day, for the current calendar month, for the current calendar year, and since system installation, including the electricity generated by the PV panels, the electricity sold to the grid, the electricity purchased from the grid, and the power consumption of the loads.

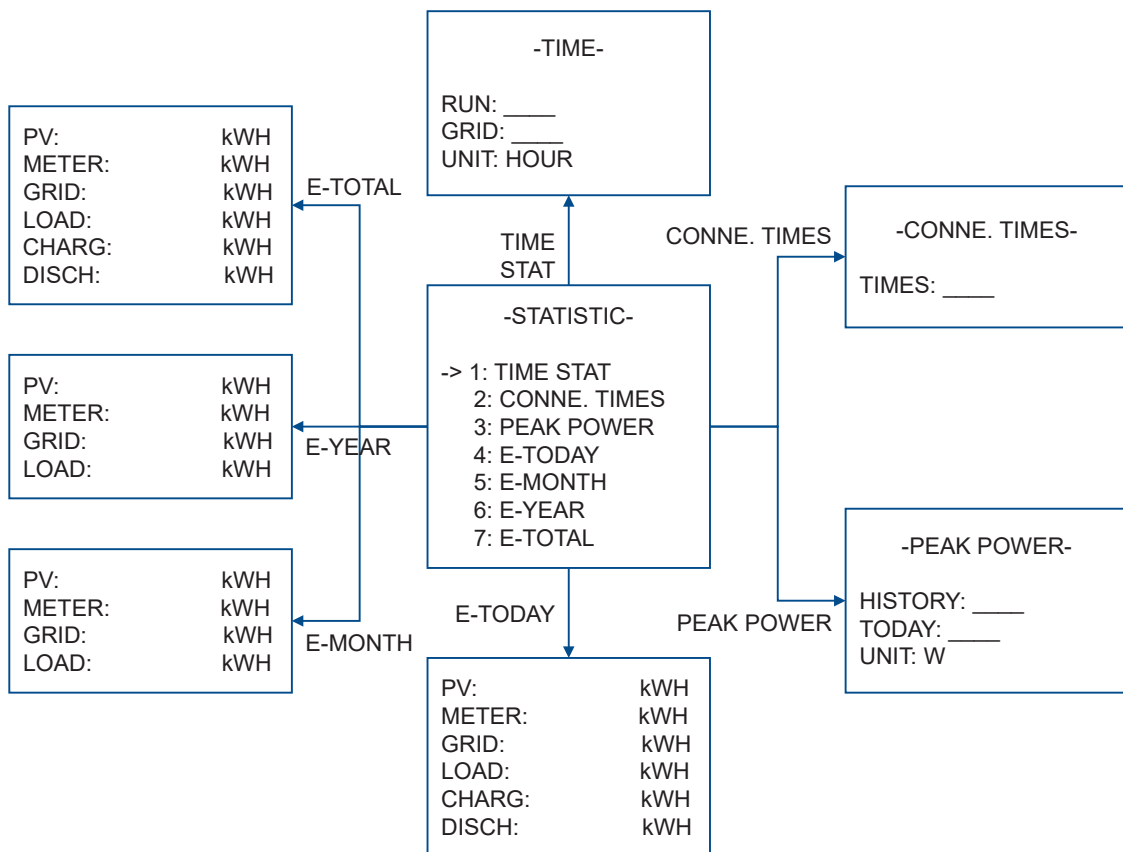
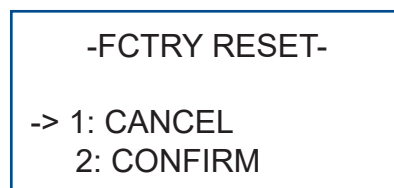



Figure 6-2 Statistics of the System



6.6 Restoring Factory Settings (FCTRY RESET)



You can reset the inverter to the default factory settings.

Step 1. On the **USER** page, press  or  to select **FCTRY RESET**.

Step 2. On the **PASSWORD** page, use  or  to enter your password.

Step 3. Press  or  to select **CONFIRM** and press .

6.7 Operating Battery Packs

6.7.1 Indicator Lights and States



The descriptions of the indicator lights and states of the battery pack in this section is applicable to BMS firmware version 1.1257 and later only.

A battery pack can be in five states: **OFF**, **NORMAL**, **ALARM**, **FAULT**, and **PROTECTION**. In each state, the battery pack can operate in different modes.

In an operation mode, the indicator lights have different blink modes: **ONCE**, **TWICE**, and **THREE**, as defined in [Table 6-4](#).

Table 6-4 Blink Modes of the Indicator Lights

| Blink Mode | | Blink | OFF |
|--------------|------------------------------------|----------------------|--------|
| ONCE | Blinks once every 4 seconds | 0.25 | 3.75 s |
| TWICE | Blinks twice every 2 seconds | 2 times of 0.25/0.25 | 1 s |
| THREE | Blinks three times every 3 seconds | 3 times of 0.25/0.25 | 1.5 s |

OFF State

When a battery pack is in the OFF state, all the indicator lights on the battery pack are OFF. To turn on the battery pack, see [Turning on a Battery Pack](#).

NORMAL State

When a battery pack is in the NORMAL state, the battery pack can be in any of three operation modes: IDLE, CHARGE, and DISCHARGE.

When the **OPERATION** indicator light blinks ONCE, and the **FAULT** indicator light is OFF, a battery pack is in the IDLE mode. In the IDLE mode, no current flows on the charging or discharging circuit and the SOC indicator lights show the battery level, as shown in [Table 6-5](#).

Table 6-5 Table 65 SOC Indicator Lights in IDLE Mode

| SOC Level | SOC Indicator Lights (From Bottom to Top) | | | |
|-----------|---|-----|-----|-----|
| 0–25% | ON | OFF | OFF | OFF |
| 26–50% | ON | ON | OFF | OFF |
| 51–75% | ON | ON | ON | OFF |
| 76–100% | ON | ON | ON | ON |

When the **OPERATION** indicator light is ON, a battery pack can run in either CHARGE or DISCHARGE mode. The CHARGE mode generates charging current (current > 0) and the DISCHARGE mode generates discharging current (current < 0). [Table 6-6](#) lists how the indicator lights work when a battery pack operates in the CHARGE and DISCHARGE modes.

Table 6-6 Indicator Lights in CHARGE and DISCHARGE Modes

| Operation Mode | Indicator Lights | | | | | |
|----------------------|------------------|-------|--------------------------|-------|-------|-------|
| | OPERATION | FAULT | SOC (From Bottom to Top) | | | |
| CHARGE to 0–25% | ON | OFF | TWICE | OFF | OFF | OFF |
| CHARGE to 26–50% | ON | OFF | ON | TWICE | OFF | OFF |
| CHARGE to 51–75% | ON | OFF | ON | ON | TWICE | OFF |
| CHARGE to 76–100% | ON | OFF | ON | ON | ON | TWICE |
| DISCHARGE to 0–25% | ON | ONCE | ON | OFF | OFF | OFF |
| DISCHARGE to 26–50% | ON | ONCE | ON | ON | OFF | OFF |
| DISCHARGE to 51–75% | ON | ONCE | ON | ON | ON | OFF |
| DISCHARGE to 76–100% | ON | ONCE | ON | ON | ON | ON |

ALARM State, FAULT State, and PROTECTION State

A battery pack can be in the ALARM, the FAULT, or the PROTECTION state. Warnings are communicated through the SOC indicator lights and/or the codes shown on the LCD screen of the inverter. For more information, see [BMS ALARM Warnings](#), [BMS FAULT Warnings](#), and [BMS PROTECTION Warnings](#).

- **ALARM:**
 - When the **OPERATION** indicator light blinks ONCE, the **FAULT** indicator light blinks twice, the SOC indicator light at the bottom blinks TWICE or is ON, and the other SOC indicator lights are OFF, this indicates LOW SOC. This warning means the SOC level of the battery is lower than 5%. When this warning occurs, you must charge the battery. For more information, see [Recharging a Battery](#).
 - When the **OPERATION** indicator light blinks THREE times and the **FAULT** indicator light is OFF, this can indicate different things depending on the states of the SOC indicator lights. For more information, see [BMS ALARM Warnings](#).
- **FAULT:** When the **OPERATION** indicator light blinks THREE times and the **FAULT** indicator light is OFF, this indicates that a battery pack is in the FAULT state.

You can determine a FAULT warning from the states of the SOC indicator lights. For more information, see [BMS FAULT Warnings](#).

When a FAULT warning occurs, you must contact Customer Service.
- **PROTECTION:** When the **OPERATION** indicator light blinks THREE times and the **FAULT** indicator light is ON, a battery pack is in the PROTECTION state.

Different PROTECTION warnings can occur in the PROTECTION state. You can determine a PROTECTION warning by the states of the SOC indicator lights. For more information, see [BMS PROTECTION Warnings](#).

6.7.2 Turning on a Battery Pack

When the battery pack is in the OFF state, to turn on the battery pack, press the button on the battery pack, hold it for more than three seconds, and then release the button.

6.7.3 Turning off a Battery Pack

When the battery pack is in the NORMAL, ALARM, or PROTECTION state, to turn off the battery pack, press the button on the battery pack, hold it for more than three seconds, and then release the button.

6.7.4 Resetting a Battery Pack

When a battery pack is in the NORMAL, ALARM, FAULT, or PROTECTION state, to reset the battery pack, follow these steps:

Step 1. Inside the cable box, set the Battery Switch to the OFF position.

Step 2. Press the button on the battery pack, hold it for more than six seconds, and then release the button.

6.7.5 Expanding Battery Capacity

It is recommended that you expand battery capacity by adding batteries within one year of the system installation.

7 Maintenance

Both users and certified professional personnel must maintain the E8KT/E10KT/E12KT energy storage system to ensure the healthy and safe operation of the system.

In this section, you can find the following:

- The inspection checklist for users of the energy storage system.
- The inspection checklist for professional personnel.
- Error codes, alarm codes, and the possible solutions of the system and the BMS.

7.1 Inspection Checklist for Users

| Inspection Activity | Interval |
|---|----------------------|
| Check for visible damage to any part of the system. | Six months |
| Check the inverter and battery packs for signs of wear and tear, heat damage, discoloration, and unusual smells. | Six months |
| Check the warning signs and guidance signs on the inverter and the battery pack for signs of wear and damage, and make sure none have been removed or obscured. | Six months |
| Check whether any part of the system makes an abnormal noise when the system is running. | Six months |
| Monitor the temperature of the battery pack and clean the battery pack if necessary. | Six months to a year |
| Make sure that the ground around the system is clean and tidy. | Six months to a year |
| Check the maintenance access to make sure that it is clear and unobstructed. | Six months to a year |
| When the system is running, check the voltage, temperature, and other parameters of the battery packs. | Six months |
| When the system is running, check the parameters of the inverters. | Six months |
| Check the battery packs for ineffectiveness or damage. | Six months |

7.2 Inspection Checklist for Professional Personnel

WARNING

- The equipment must be opened only by professional personnel that have been certified by KSTAR New Energy.
- During inspection and maintenance, wear protective personal equipment, including insulated gloves, protective shoes, and anti-noise earplugs.
- Follow local and international safety standards, regulations, and specifications to do the maintenance.
- Contact KSTAR New Energy promptly if you encounter anything not covered in this manual.

CAUTION

Before maintenance, disconnect all the electrical connections. Wait at least five minutes after disconnection, so that the residual voltage of the capacitors falls to a safe voltage. Use a multi-meter to make sure that the equipment is completely discharged.

| Inspection Activities | Interval |
|---|----------------------|
| Check electrical connections for looseness. | Six months to a year |
| Check cables for deterioration or damage. | Six months to a year |
| Check cable terminal screws for looseness. | Six months to a year |
| Check cable terminals for signs of overheating. | Six months to a year |
| Check the ground connection. | Six months to a year |
| Check whether the cable tie is attached to the cable. | Six months to a year |
| Check the EMS, SOLARMAN app, and other related equipment for failure or damage. | Six months to a year |

7.3 Troubleshooting

When you see an error code or alarm code on the LCD screen of the inverter, you can find possible solutions in this section. If the problem persists after trying these solutions, please contact KSTAR New Energy or an authorized distributor.

When a problem is successfully solved, the error code or alarm code on the LCD screen automatically disappears after a certain time delay, but you can always view it in the error records. For more information, see [Viewing INQUIRE](#).

7.3.1 Error Codes of the System

| Code | Description | Possible Solutions |
|------------|--|---|
| F00 | Soft Time Out: Soft-start timeout. | Restart the inverter and wait until it runs correctly. If the code is still shown, contact Customer Service. |
| F01 | INV Volt Short: The inverter output is shorted. | <ol style="list-style-type: none"> 1. Disconnect all power sources and shut down the inverters and the battery packs. 2. Disconnect the load. 3. Power on and restart all the inverters and the battery packs. 4. If no error is reported, it means the load is shorted. Check the load. If the code is still shown, contact Customer Service. |
| F02 | GFCI Sensor Fault: A failure occurs to the Ground Fault Circuit Interrupter (GFCI) sensor. | <ol style="list-style-type: none"> 1. Disconnect all power sources. 2. Restart the inverter and wait until it runs correctly. If the code is still shown, contact Customer Service. |
| F04 | Bus Volt Low: The bus voltage is low. | <ol style="list-style-type: none"> 1. Check the settings of the input mode. 2. Restart the inverter and wait until it runs correctly. If the code is still shown, contact Customer Service. |
| F05 | Bus Volt High: The bus voltage is high. | |
| F06 | Bus Short Circuit: The bus is shorted. | Restart the inverter and wait until it runs correctly. If the code is still shown, contact Customer Service. |
| F07 | PV ISO Under Fault: The insulation resistance of a PV panel is low. | <ol style="list-style-type: none"> 1. Check the ground connection. 2. Check the ground resistance of PV+ and PV-: <ul style="list-style-type: none"> ▪ If the resistance is smaller than 2 MΩ, check the PV string for ground fault or poor ground insulation. If necessary, contact Customer Service. ▪ If the resistance is greater than 2 MΩ and the error code is still shown, contact Customer Service. |

| Code | Description | Possible Solutions |
|------------|--|--|
| F08 | PV Input Short Circuit: The PV input is shorted. | <ol style="list-style-type: none"> 1. Check the settings of the input mode. 2. Disconnect the PV input. 3. Restart the inverter and wait until it runs correctly. <p>If the code is still shown, contact Customer Service.</p> |
| F09 | Bypass Relay Fault: A failure occurred to the bypass relay. | <ol style="list-style-type: none"> 1. Disconnect the PV input. 2. Restart the inverter and wait until it runs correctly. |
| F19 | EPS Relay Fault: A failure occurred to the backup relay. | <p>If the code is still shown, contact Customer Service.</p> |
| F10 | INV Curr Over: The output current on the inverter exceeds the threshold. | <ol style="list-style-type: none"> 1. Wait five minutes for the inverter to restart automatically. 2. Check the backup loads. If the load exceeds the rated output power of the inverter, disconnect some load. <p>If the code is still shown, contact Customer Service.</p> |
| F11 | INV DC Over: The DC component of the output current of the inverter is too high. | <p>Restart the inverter and wait until it runs correctly.</p> <p>If the code is still shown, contact Customer Service.</p> |
| F12 | Ambient Over Temp: The ambient temperature is too high. | <ol style="list-style-type: none"> 1. Restart the inverter. 2. Let the inverter cool for a few minutes and then restart it. |
| F13 | Sink Over Temp: The temperature of the heat sink is too high. | <ol style="list-style-type: none"> 3. Observe whether the inverter can run correctly. 4. Make sure that the ambient temperature is in the range of -25°C to 60°C. <p>If the code is still shown, contact Customer Service.</p> |
| F15 | DisChg Curr Over: The battery is discharged with over current. | <ol style="list-style-type: none"> 1. Wait five minutes for the inverter to restart automatically. 2. Check the backup loads. If the load exceeds the rated output power of the inverter, disconnect some load. <p>If the code is still shown, contact Customer Service.</p> |

| Code | Description | Possible Solutions |
|------------|---|---|
| F16 | Chg Curr Over: The battery is charging with over current. | Check the battery wiring port for short circuits. Restart the inverter and the battery packs. If the code is still shown, contact Customer Service. |
| F17 | Current Sensor Fault: A failure occurred to the current sensor. | Restart the inverter and wait until it runs correctly. If the code is still shown, contact Customer Service. |
| F18 | INV Abnormal: Abnormal output voltage or output frequency of the inverter. | Contact Customer Service. |
| F20 | Always Over Load: The backup load always exceeds the rated output power of the system. | Check the backup loads. If the load is lower than the rated output power of the inverter and the error is still shown, contact Customer Service. |
| F21 | SPI Fault Between DSP: A failure occurred to the communication between DSPs. | Restart the inverter and wait until it runs correctly. Restart the inverter and wait until it runs correctly. |
| F22 | Parallel Communicate Fault: A failure occurred to the communication between the inverters in a parallel system. | 1. Check the parallel cable for connection. 2. Check the inverter address settings. In a parallel system, the address of the primary inverter must be set to 1, and the addresses of the other inverters must be set to 2, 3, or 4. If the code is still shown, contact Customer Service. |
| F23 | Parallel Grid Abnormal: In a parallel system, some connections are incorrect. | 1. Check the wiring at the grid end and make sure the wiring is correct. 2. Restart the inverter and wait until it runs correctly. If the code is still shown, contact Customer Service. |
| F24 | Backup Air Switch Abnormal: An error occurred to activation of the air switch on the backup load end. | 1. Turn off all the switches on the backup load end. 2. If the code is still shown, contact Customer Service. |
| F25 | Parallel Power Imbalance: Power imbalance occurs to the parallel system. | 1. Turn off all the switches on the backup load end. 2. Restart the inverter and wait until it runs correctly. |

| Code | Description | Possible Solutions |
|------------|---|---|
| F26 | Parallel Inverter Grid Phase Sequence Abnormal | <ol style="list-style-type: none"> 1. Make sure that the phase sequence at the grid end of the inverter is consistent. 2. If the code is still shown, contact Customer Service. |
| F32 | DSP ARM SCI Fault: A failure occurs to the communication between DSP and ARM. | <p>Restart the inverter and wait until it runs correctly.</p> <p>If the code is still shown, contact Customer Service.</p> |

7.3.2 Alarm Codes of the System

| Code | Description | Possible Solutions |
|------------|---|--|
| W00 | Grid Volt Low | <p>Check the local voltage and frequency for their compliance with the inverter specifications:</p> <ul style="list-style-type: none"> • If the voltage and frequency are within the acceptable range, wait two minutes for the inverter to run correctly. If recovery is not possible or the fault repeats, contact Customer Service. • If the voltage and frequency are beyond the range or are unstable, contact the local power company. |
| W01 | Grid Volt High | |
| W02 | Grid Frequency Low | |
| W03 | Grid Frequency High | |
| W04 | Solar Loss: No PV solar panels are connected to the system, or the input voltage from the PV solar panels is too low. | <ol style="list-style-type: none"> 1. Check the PV connection. 2. Check the PV availability. <p>If the connections are correct and the alarm code is still shown, contact Customer Service.</p> |
| W05 | Bat Loss: No battery packs are connected to the system, or the battery voltage is too low. | <ol style="list-style-type: none"> 1. Check the battery connection. 2. Check the battery wiring port for short circuits. <p>If the connections are correct and the alarm code is still shown, contact Customer Service.</p> |
| W06 | Bat Under Volt: Under voltage has occurred in the battery. | <p>Check the battery packs for their availability. If the battery voltage is lower than the lowest battery terminal input voltage acceptable to the inverter, charge the battery until it reaches the acceptable battery input voltage of the inverter.</p> <p>If the code is still shown, contact Customer Service.</p> |
| W07 | Bat Volt Low: The battery voltage is too low. | |

| Code | Description | Possible Solutions |
|--|---|--|
| W08 | Bat Volt High: The battery voltage is higher than 57.5 V and the battery has shut down because of the high voltage. | <ol style="list-style-type: none"> 1. Check the battery for its compliance with its pre-settings. 2. If the battery complies with the pre-setting, restart it. If the code is still shown, contact Customer Service. |
| W09 | Over Load: An overload has occurred because the connected load exceeds the rated power of the inverter. | <ol style="list-style-type: none"> 1. Wait five minute for the inverter to restart. 2. If the backup loads are higher than the rated output power of the inverter, disconnect some load. |
| W10 | GFCI Over: High current leakage has occurred. | <ol style="list-style-type: none"> 1. Check the PV string for direct or indirect grounding. If such grounding is discovered, correct it. 2. Check the peripherals of the inverter for current leakage. If current leakage is discovered, address it. If the code is still shown, contact Customer Service. |
| W12 | Fan Fault: The fan has malfunctioned. | Restart the inverter and wait until it runs correctly. If the code is still shown, contact Customer Service. |
| W13 | BAT Power Down: The battery has shut down because the SOC is low. | Check the SOC. Make sure that the SOC is not lower than the difference between 100% and the set DOD. If it is lower than the difference, charge the battery. |
| W14 W15 W16 W17 W18 W21 W22 | BMS alarms. | For more information, see BMS ALARM Warnings . |
| W19 | BMS Volt Imbalance: A voltage imbalance has occurred to the battery of the BMS. | Contact Customer Service. |
| W20 | BMS Communicate Fault: The communication between the BMS and the inverter has failed. | Make sure that the COM cable between the inverter and the battery pack is in good condition and is connected correctly. |
| W23 W24 | BMS protection warning. | For more information, see BMS PROTECTION Warnings . |

| Code | Description | Possible Solutions |
|------------|--|---|
| W25 | BMS Updating: The BMS is updating. | You can ignore this alarm. No action is required. |
| W26 | BMS Program Version Err: The version of the BMS program is incorrect. | Contact Customer Service. |
| W27 | BMS Program Update Fail: The BMS program has failed to update. | Check the network and try to update the program again. |
| W29 | Grid Volt Lock Fail: The inverter has failed to synchronize with the grid. | Restart the inverter and wait until it runs correctly. If the code is still shown, contact Customer Service. |
| W30 | PV Off: The PV string has requested a shutdown. | Restart the inverter and wait until it runs correctly. If the code is still shown, contact Customer Service. |
| W31 | System Reset: The system is reset. | Restart the inverter and wait until it runs correctly. If the code is still shown, contact Customer Service. |

7.3.3 BMS ALARM Warnings

When a battery pack is in the ALARM state, a LOW SOC warning and other ALARM warnings can occur.

For more information about the LOW SOC warning, see the [ALARM State](#), [FAULT State](#), and [PROTECTION State](#) subsection under [Indicator Lights and States](#).

When the OPERATION indicator light blinks THREE times and the FAULT indicator light is OFF, you can know the other ALARM warnings through the states of the SOC indicator lights and the alarm codes shown on the LCD screen of the inverter. [Table 7-1](#) lists these ALARM warnings. In this table, “MODULE” means a battery pack and “CELL” means a battery cell.



You can also check the alarm codes through **INQUIRE -> BMS INFO** in the integrated EMS. For more information, see [Viewing INQUIRE](#).

“N/A” (Not Applicable) in the “Code” column of [Table 7-1](#) means no code is assigned to the alarm.

Table 7-1 ALARM State: Indicator Lights, Codes, and Possible Solutions

| Code | ALARM Warning | SOC (From Bottom to Top) | | | | Description | Possible Solutions |
|---|------------------------|--------------------------|-----|-----|-----|--|--|
| | | | | | | | |
| W16 | MODULE OVER VOLTAGE | ON | ON | ON | ON | The battery is nearing full charge. | You can ignore this alarm. No action is required. |
| W21 | MODULE UNDER VOLTAGE | OFF | ON | ON | ON | The battery nearing full discharge. | You can ignore this alarm. No action is required. |
| W16 | CELL OVER VOLTAGE | ON | OFF | ON | ON | The battery is nearing full charge. | You can ignore this alarm. No action is required. |
| W21 | CELL UNDER VOLTAGE | OFF | OFF | ON | ON | The battery is nearing full discharge. | You can ignore this alarm. No action is required. |
| W17 | CELL OVER TEMPERATURE | ON | OFF | OFF | ON | The cell temperature is too high. | You can ignore this alarm. No action is required. |
| Charge: W18 Discharge: W22 | CELL UNDER TEMPERATURE | OFF | OFF | OFF | ON | The cell temperature is too low. | You can ignore this alarm. No action is required. |
| W15 | CHARGING OVER CURRENT | ON | ON | ON | OFF | The charging current is too high. | Lower the charging current. |
| W14 | DISCHARGE OVER CURRENT | OFF | ON | ON | OFF | The discharging current is too high. | Lower the discharging current. |
| N/A | LOW SOC ALARM | ON | ON | OFF | OFF | When the battery pack runs in the IDLE or DISCHARGE mode, a LOW SOC alarm can occur when SOC is too low. | Recharge the battery. For more information, see Recharging a Battery . |

7.3.4 BMS FAULT Warnings

When the **OPERATION** indicator light blinks THREE times and the **FAULT** indicator light is OFF, the battery pack is in the FAULT state. You can know the FAULT warnings through the SOC indicator lights and the alarm codes shown on the LCD screen of the inverter.

When a FAULT warning occurs, you must contact Customer Service.

[Table 7-2](#) lists all FAULT warnings. In this table, “MODULE” means a battery pack and “CELL” means a battery cell.



You can also know the alarm codes through **INQUIRE -> BMS INFO** in the integrated EMS. For more information, see [Viewing INQUIRE](#).

“N/A” (Not Applicable) in the “Code” column of [Table 7-2](#) means no code is assigned to the alarm.

Table 7-2 FAULT State: Indicator Lights, Codes, and Possible Solutions

| Code | FAULT Warning | SOC (From Bottom to Top) | | | | Description | Possible Solutions |
|------|---------------------|--------------------------|-----|-----|-----|---|---|
| N/A | CHARGE MOS FAULT | ON | ON | OFF | ON | When the charging MOSFET is OFF, the current on the circuit is positive. | Disconnect the release to disable the battery pack and contact Customer Service to check the charging MOSFET on the BMS circuit board for short circuits. |
| N/A | DISCHARGE MOS FAULT | OFF | ON | OFF | ON | When the discharging MOSFET is OFF, the current on the circuit is negative. | Disconnect the release to disable the battery pack and contact Customer Service to check the discharging MOSFET on the BMS circuit board for short circuits. |
| N/A | CELL SAMPLING FAULT | ON | OFF | ON | OFF | BMS fault. | Contact Customer Service to check the cell sampling wires and the wiring of the BMS circuit board. Make sure that the BMS circuit board is powered correctly. |

| Code | FAULT Warning | SOC (From Bottom to Top) | | | | Description | Possible Solutions |
|------|--------------------------------|--------------------------|-----|-----|-----|--|---|
| | | | | | | | |
| N/A | HEATING FAULT | OFF | OFF | ON | OFF | BMS fault. | Contact Customer Service to check the heating film circuit. Make sure that the three-terminal fuse is not blown and the circuit is running correctly. |
| N/A | TEMPERATURE SENSOR MALFUNCTION | OFF | ON | OFF | OFF | BMS fault. | Contact Customer Service to check the connection of the temperature sensor and wiring of the BMS circuit board. Make sure that the temperature sensor is running correctly. |
| N/A | BATTERY CELL MALFUNCTION | ON | OFF | OFF | OFF | The voltage difference between cells exceeds 1 V. | Contact Customer Service to check the cell sampling wires and the wiring of the BMS circuit board. Make sure that the BMS circuit board is powered correctly. |
| N/A | COMMUNICATION FAILURE | OFF | OFF | OFF | OFF | Internal communication of the battery pack has failed. | Contact Customer Service to check the circuit board. |

7.3.5 BMS PROTECTION Warnings

When the **OPERATION** indicator light blinks THREE times and the **FAULT** indicator light is ON, the battery pack is in the PROTECTION state.

Under a condition that causes the PROTECTION state, the battery management system (BMS) automatically protects the battery pack and makes the battery pack enter the PROTECTION state. When the condition is no longer present, the PROTECTION warning is cleared automatically and the battery pack automatically exits the PROTECTION state. If a PROTECTION warning cannot be cleared automatically, contact Customer Service.

You can know the PROTECTION warnings through the SOC indicator lights and the alarm codes shown on the LCD screen of the inverter. [Table 7-3](#) lists all PROTECTION warnings. In this table, “MODULE” means the battery pack and “CELL” means the battery cell.



You can also know the alarm codes through **INQUIRE -> BMS INFO** in the integrated EMS. For more information, see [Viewing INQUIRE](#).

“N/A” (Not Applicable) in the “Code” column of [Table 7-3](#) means no code is assigned to the protection warning.

Table 7-3 PROTECTION State: Indicator Lights, Codes, and Possible Solutions

| Code | PROTECTION Warning | SOC (From Bottom to Top) | | | | Description | Possible Solutions |
|------|---------------------------------------|--------------------------|-----|----|----|---|---|
| N/A | SHORT CIRCUIT PROTECTION | ON | ON | ON | ON | The discharging current is too high. | When this warning occurs, the BMS will disconnect the discharging circuit for 30 seconds. During the disconnection, you must remove the external loads of the battery pack. 30 seconds later, the SHORT CIRCUIT PROTECTION warning will be automatically cleared. |
| N/A | CHARGE PROTECTION MODULE OVER VOLTAGE | OFF | ON | ON | ON | The battery is fully charged. | The BMS will disconnect the charging circuit automatically. DO NOT continue charging the battery pack. |
| N/A | PROTECTION MODULE OVER CURRENT | ON | OFF | ON | ON | The current is higher than the set threshold. | The BMS will disconnect the circuit automatically. One minute later, the connection will be restored. You should limit the current. |

| Code | PROTECTION Warning | SOC (From Bottom to Top) | | | | Description | Possible Solutions |
|------|---------------------------------|--------------------------|-----|-----|----|--|--|
| W23 | PROTECTION MODULE OVER VOLTAGE | OFF | OFF | ON | ON | The total voltage of the battery has been charged to the upper limit. | The BMS will disconnect the charging circuit automatically. DO NOT continue charging the battery. |
| N/A | PROTECTION MODULE UNDER VOLTAGE | ON | ON | OFF | ON | The total voltage of the battery has been discharged to the lower limit. | The BMS will disconnect the discharging circuit automatically. You must recharge the battery. For more information, see Recharging a Battery . |
| N/A | PROTECTION REVERSE POLARITY | OFF | ON | OFF | ON | The positive and negative polarities are reversed. | Check the connection of the power supply of the battery pack for reverse connection. |
| N/A | CELL OVER VOLTAGE | ON | OFF | OFF | ON | The battery cell has been charged to the upper limit. | The BMS will disconnect the charging circuit automatically. DO NOT continue charging the battery pack. |
| N/A | CELL UNDER VOLTAGE | OFF | OFF | OFF | ON | The battery cell has been discharged to the lower limit. | The BMS will disconnect the discharging circuit automatically. You must recharge the battery. For more information, see Recharging a Battery . |

| Code | PROTECTION Warning | SOC (From Bottom to Top) | | | | Description | Possible Solutions |
|------------|--|--------------------------|-----|-----|-----|--|--|
| W24 | CELL OVER TEMPERATURE CHARGE/ DISCHARGE | ON | ON | ON | OFF | The temperature of the battery cell has reached the upper limit. | Check the ambient temperature around the battery pack. Make sure that the temperature is not too high. Make sure that the battery is not fully charged and discharged for a long period of time. |
| N/A | CELL UNDER TEMPERATURE CHARGE/ DISCHARGE | OFF | ON | ON | OFF | The temperature of the battery cell has reached the lower limit. | Check the ambient temperature around the battery pack. Make sure that the temperature is not too low. |
| N/A | AMBIENT OVER TEMPERATURE | ON | OFF | ON | OFF | The ambient temperature has reached the upper limit. | Check the ambient temperature around the battery pack. Make sure that the temperature is not too high. |
| N/A | AMBIENT UNDER TEMPERATURE | OFF | OFF | ON | OFF | The ambient temperature has reached the lower limit. | Check the ambient temperature around the battery pack. Make sure that the temperature is not too low. |
| N/A | MOSFET OVER TEMPERATURE | ON | ON | OFF | OFF | The temperature of the MOSFET has reached the upper limit. | Check the ambient temperature around the battery pack. Make sure that the current is not too high. Make sure that the battery is not fully charged and discharged for a long period of time. |

| Code | PROTECTION Warning | SOC (From Bottom to Top) | | | | Description | Possible Solutions |
|------|--------------------|--------------------------|-----|-----|-----|---|--|
| N/A | LOCKED | OFF | OFF | OFF | OFF | The battery pack is locked because the voltage or the temperature exceeds the upper limits or falls below the lower limit. When the battery pack is locked, charging or discharging is not permitted. | Make sure there is no over voltage, under voltage, over temperature, or under temperature protection warning, and then press the button and hold it for 20 seconds to unlock the battery pack. |

8 Storing and Recharging Batteries

8.1 Storage Environment Requirements

It is recommended that you begin using the battery soon after delivery rather than store the battery pack for a long time. The maximum storage life of a battery pack is three years.

The intended storage environment of the battery pack must meet these requirements:

- Ambient temperature: -10°C to 45°C.
- Recommended storage temperature: 20°C to 30°C.
- Relative humidity: 0–95% (No condensation).
- Dry, ventilated, and clean area.
- No contact with corrosive organic solvents, gases, and other substances.
- No direct sunlight.
- More than two meters from any heat source.

WARNING

When storing a battery in its packaging, make sure that the packaging box is intact and that the battery is appropriately placed and stacked, and the above mentioned requirements are met.

8.2 Interval for Recharging Batteries

While in storage, batteries must be recharged at specified intervals.

Table 8-1 Recharge Batteries at Specified Intervals During Storage

| Actual Storage Temperature | Interval |
|--|-----------|
| $-10^{\circ}\text{C} \leq T \leq 30^{\circ}\text{C}$ | 12 months |
| $30^{\circ}\text{C} < T \leq 45^{\circ}\text{C}$ | 8 months |

Battery packs must be recharged a maximum of three times within a 3-year period. For example, whether the battery is recharged every 8 months or every 12 months, it can only be recharged a maximum of three times within three years. If the battery has not been recharged within three years, or if it has been recharged more than three times within three years, it is recommended that the battery pack be discarded.

Lithium-ion batteries lose capacity during storage. After 12 months of storage at the intended storage temperature, the capacity generally falls irreversibly by 3–10%. Batteries with less than 100% capacity after storage cannot pass the discharge testing and acceptance testing.

8.3 Recharging a Battery

If a battery has not been charged for two weeks or more after a deep discharge, or the SOC of a battery is less than 50% after a long period of storage, the battery must be charged to 50%.

WARNING

Before charging the battery, check it for deformation, case damage, or leakage, and if you find any of these things, do not charge the battery.



If the SOC of a battery pack is not less than 50% after more than 12 months of storage, it is not necessary to recharge the battery.

NOTES

Prepare a cross screwdriver and insulated rubber gloves.

CAUTION

When you connect the power wires, wear insulated rubber gloves.

PROCEDURE

- Step 1.** If the battery pack has been stored for a long time, unpack the battery pack and connect it to the system.
- Step 2.** On the integrated EMS, set **DISC DEPTH** to **95%**. For more information, see the [DISC DEPTH](#) subsection under [BAT SETTING](#).
- Step 3.** On the integrated EMS, set **WORK MODE** to **PEAK SHIFT** and set the inverter to **DISCHG**. For more information, see the [WORK MODE](#) subsection under [SYS SETTING](#).

On the battery pack, press the button. Check the indicator lights. If only the bottom one or two SOC indicator lights are ON and the **FAULT** indicator light is OFF, then the battery pack is in good working order.



If the battery is in good working order, contact Customer Service.

- Step 4.** Open the side cover of the battery pack and check the dip switches.
For BluE-PACK-5.1-16S-100A-F: There are no dip switches. Go to Step 5.
For BluE-PACK5.1: Turn the dip switch numbered **1** to the **ON** position and make sure that all the other dip switches are in the OFF state. For more information, see [Table 3-1](#).
- Step 5.** Use the COM cable to connect the BAT port inside the cable box and the INV port on the battery pack, and then use the BAT cables to connect the BAT+ and BAT- ports inside the cable box and the battery pack.
- Step 6.** On the side of the battery pack, set the DC Switch or Battery Switch to ON, and inside the cable box, set the Battery Switch to ON.



When only one battery pack is connected to a three-phase inverter, the **PROTECTION MODULE OVER CURRENT** warning can occur after flipping the Battery Switch inside the cable box. To solve it, follow these steps:

- 1 Set the Battery Switch inside the cable box and the DC Switch or Battery Switch on the side of the battery pack to the OFF position.
- 2 On the battery pack, press the button and hold it for six seconds to restart the battery pack.

- Step 7.** On the battery pack, press the button and hold it for three seconds to turn on the battery pack.
- Step 8.** On the LCD screen, view the **BATTERY** and **BMS PARAM** information. For more information, see [Viewing the Current System Information](#). The rated charge and discharge current of the battery are 50 A and **80 A**.
- Step 9.** Wait for the inverter to discharge the battery.
On the **BATTERY** page, the discharge current is in the range of 70 A–80 A.
- Step 10.** On the **BMS PARAM** page, check the SOC.
When the battery is discharged to less than 4%, the inverter reports **W07** and **W13**, as shown on the **ERROR NO.** page.
- Step 11.** On the **WORK MODE** page of the integrated EMS, enable **SELF CONSUME**, set **CHARGE TIME** to **00:00–23:59**, and set MAX SOC to **50%**. For more information, see the [WORK MODE](#) subsection under [SYS SETTING](#).
- Step 12.** Wait for the inverter to charge the battery.
On the **BATTERY** page, the charge current is in the range of 40 A–50 A.

Step 13. When the **MAX SOC** (50%) is reached, as shown on the **BMS PARAM** page, power off the battery pack, set the Battery Switch or Battery Switch inside the cable box to OFF, set the DC Switch on the side of the battery pack to OFF, and disconnect the COM cable and the BAT cables between BAT+ and BAT-.

For BluE-PACK5.1: On the side of the battery pack, turn the dip switch numbered 1 to the OFF position and make sure that all the other dip switches are in the OFF state. For more information, see Step 4.

Step 14. Close the side cover of the battery pack.

Step 15. If the battery pack was stored, move the battery pack into the package box.

Step 16. If more battery packs must be recharged, follow steps 1 through 15.

Step 17. After all the battery packs are recharged, reset the inverter to the default factory settings. For more information, see [Restoring Factory Settings \(FCTRY RESET\)](#).

9 Limited Warranty

If the equipment fails during the warranty period, KSTAR New Energy and its authorized partners will provide free service or replace the unit or part with a new one.

9.1 When the Warranty Period Starts and Ends

Starting from the date on which you purchase the equipment, you are entitled to these warranty services:

- A 5-year product warranty service for the hybrid inverter and the battery packs.
- A 10-year performance warranty service for the battery packs.

9.2 What This Warranty Covers

During the warranty service, the professional personnel certified by KSTAR New Energy or its authorized partners will determine the problem based on the current status of the equipment, confirm the time required for repair or replacement, and complete the repair or replacement within the agreed time.

If a unit or part is replaced, the replaced unit or parts will be recycled and disposed of by KSTAR New Energy or its authorized partners.

The replacement unit or parts provided by KSTAR New Energy are determined by the inventory and may not be brand new, but are bound to be in good working condition and at least functionally equivalent to a brand new unit or part. The replacement unit or part will be warranted for the remainder of the original warranty period of the equipment.

9.3 How to Obtain Warranty Service

If the equipment does not function as warranted during the warranty period, you can contact KSTAR New Energy or its authorized partners to obtain warranty service.

9.4 Customer Responsibility for Warranty Service

To obtain warranty service, you must take these steps:

- Step 1.** Provide the purchase invoice to prove that the whole unit or parts are still under warranty.
- Step 2.** Make sure that the nameplate on the equipment is intact and legible.
- Step 3.** Make sure that the installation, modification, replacement, or removal of the whole unit or part of the equipment has been done by professional personnel certified by KSTAR New Energy or its authorized partners.

- Step 4.** Make sure that the equipment has been operated in the intended environment described in this manual or other documents provided by KSTAR New Energy.
- Step 5.** Make sure that no non-standard parts or parts not supplied by KSTAR New Energy are used in the equipment.

Failure to comply with any of the above information, KSTAR New Energy or its authorized partners have the right to refuse to provide warranty service.

9.5 Limitation of Liability

KSTAR New Energy has the right to refuse to honor the quality warranty for any of the following reasons:

- Damage during transportation, including paint scratches caused by friction inside the package during transportation, and damage sustained while being transported by you or a third party commissioned by you.
- Operation of the equipment in an environment other than the intended environment described in this manual or other documents provided by KSTAR New Energy.
- Failure or damage caused by installation, repair, modification, or disassembly carried out by anyone other than professional personnel certified by KSTAR New Energy or its authorized partners.
- Failure or damage caused by the use of non-standard components or other components not provided by KSTAR New Energy.

KSTAR New Energy may charge a fee for repair service if you request repair of the equipment in any of the following circumstances:

- Installation and use beyond the scope of the relevant standards.
- Damage caused by unexpected natural factors.

10 Emergency Procedure

An emergency is a situation involving a major incident or the possibility of a major incident that cannot be handled according to normal procedures and requires immediate action to limit or address the consequences.

This section describes emergencies that may be encountered when you are using the E8KT/E10KT/E12KT energy storage system and how to handle such emergencies.

10.1 General Handling

If an emergency occurs, remember the following:

- The grid main switch that supplies power directly to the BESS must be turned off.
- All load switches in the BESS must be turned off.
- The battery switch must be turned off.
- If you want to open the inverter or the battery pack after the power is turned off, to prevent possible fatal personal injury, use a properly calibrated voltage meter to measure the voltage at the input terminals, wait approximately 15 minutes until the DC link capacitors inside the battery pack is completely discharged, and then open the top cover to repair.

WARNING

Before operating the equipment, make sure that the BESS is not supplied with grid power.

10.2 Potential Emergencies

10.2.1 Battery Leakage

If the battery pack leaks electrolyte, avoid contact with the leaking liquid or gas. If you contact with the leaking substance, take the measures listed in [Table 10-1](#) immediately.

Table 10-1 Measures to Solve Battery Leakage Emergency

| Exposure | Measures |
|--------------|---|
| Inhalation | Evacuate contaminated area, and then seek medical attention. |
| Eye Contact | Flush eyes with running water for five minutes, and then seek medical attention. |
| Skin Contact | Wash affected area thoroughly with soap and water, and then seek medical attention. |
| Ingestion | Induce vomiting, and then seek medical attention. |

10.2.2 Fire or Explosion

If a fire occurs in the area where the battery pack is installed, take the following measures.

WARNING

Batteries can explode when heated over 150°C. Toxic gases can leak when a battery pack burns. **DO NOT** approach. However, because the batteries contain only a small amount of oxygen and all batteries are equipped with explosion-proof valves, battery explosions are unlikely to occur.

Table 10-2 Handling with Fire

| Handling with Fire | Description |
|-------------------------------|---|
| Fire Extinguishing Agent | <p>A respirator is not usually required.</p> <p>If the fire is caused by a battery, use a specialized fire extinguisher such as Noves 1230, FM-200, or a dioxin extinguisher.</p> <p>If the fire is not caused by a battery, use a regular ABC extinguisher.</p> |
| Extinguishing Instructions | <p>If a fire occurs while charging a battery, turn off the battery pack circuit breaker and turn off the charging power if it is safe to do so.</p> <p>If the battery pack is not on fire, the fire should be extinguished before the battery pack catches fire.</p> <p>If the battery pack is on fire, do not attempt to extinguish the fire. Instead, evacuate personnel immediately.</p> |
| Methods of Handling Accidents | <p>If the battery is in a dry environment, put the damaged battery in an isolated area and call the local fire department or service engineer.</p> <p>If the battery is in a wet environment, DO NOT touch anything if any part of the battery, such as the inverter or cables, is submerged. DO NOT use the submerged battery. Contact a service engineer.</p> |

10.3 Emergency Handling Plan

If an emergency occurs, follow this emergency handling plan:

- Step 1.** Turn off the AC circuit breakers.
- Step 2.** Check the control power supply. If there is no problem, supply power to the inverter again to find the cause.
- Step 3.** Record the details related to the fault so that KSTAR New Energy can analyze and rectify the fault. **DO NOT** operate the equipment before the fault is rectified. Please contact KSTAR New Energy as soon as possible.



CAUTION

When the FAULT indicator light on the battery pack is ON, please do a check and contact our Customer Service.

11 Disposal

When the system reaches the end of its service life, follow these steps to dispose of the equipment:

Step 1. Uninstall the system:

- 1.1 Disconnect all power sources.
- 1.2 Disassemble all parts of the system from top to bottom.

Step 2. Dispose of all the parts. **DO NOT** dispose of the inverters, the battery packs, and the stick loggers as regular household waste.

| | |
|---|--|
|  | <p>This symbol means that the labeled equipment must not be disposed of as regular household waste. It must be disposed of at an electrical and electronic equipment-recycling center.</p> |
|---|--|

NOTICE

If you need to replace a battery pack, you should request a new dangerous goods package, pack the battery pack, and then have the supplier pick it up.

KSTAR New Energy does not recycle batteries. Please contact your local recycling organization for disposal. If there is no local recycling organization, you should contact the nearest recycling organization in your country.

12 Specifications

12.1 Hybrid Inverter

| | |
|--|---|
| Dimension (W × H × D, mm) | 540 × 980 × 240 |
| Net Weight (kg) | 49 |
| Operating Temperature | -25°C to +60°C, derated over 40°C |
| Operating Relative Humidity | 0–95% (No condensation) |
| Operating Altitude | ≤ 2000 m |
| Protective Class | Class I |
| Overvoltage Category | II (DC side), III (AC side) |
| Topology | High Frequency Isolation |
| Cooling | Natural Convection |
| Display | LCD/APP |
| Communication Interface | RS485, CAN2.0, Wi-Fi, and 4G |
| Ingress Protection | IP65 |
| Max. Conversion Efficiency (From Battery) | 94.0% |
| Max. Conversion Efficiency (From PV) | 97.6% |
| Euro Efficiency | 97.0% |
| MPPT Efficiency | 99.5% |
| Protection Function | <ul style="list-style-type: none"> • Short Circuit Protection • AC Leakage Fault Protection • Grounding Fault Protection • Anti-islanding Protection • Overload Protection • Surge Protection • DC Polarity Protection |
| Grid Regulation | <ul style="list-style-type: none"> • EN50549-1 • VDE-AR-N4105 • VDE0126-1-1 <p>More grid regulation certifications are to be made available. Please contact KSTAR New Energy for the latest information.</p> |
| Safety Regulation | <ul style="list-style-type: none"> • IEC/EN 62109-1&2 • IEC62040-1 • IEC62619 |

| | |
|------------|--|
| EMC | <ul style="list-style-type: none"> • EN61000-6-1 • EN61000-6-2 • EN61000-6-3 • EN61000-6-4 • EN61000-3-2 • EN61000-3-3 • EN61000-3-11 • EN61000-3-12 |
|------------|--|

12.2 Battery Terminal Input/Output

| | E8KT | E10KT | E12KT |
|---|--------------------------------|------------------|------------------|
| Battery Type | Lithium or lead-acid batteries | | |
| Voltage Range | 44–58 VDC | | |
| Rated Voltage | 51.2 VDC | | |
| Maximum Charge/Discharge Current | 160 ADC/160 ADC | 160 ADC/200 ADC | 160 ADC/200 ADC |
| Maximum Charge/Discharge Power | 8,000 W/8,000 W | 8,000 W/10,000 W | 8,000 W/10,000 W |

12.3 PV Input

| | E8KT | E10KT | E12KT |
|---|--|--------------|--------------|
| Vmax. PV | 1,100 VDC | | |
| Rated Voltage | 720 VDC | | |
| PV Start Voltage | 350 VDC (Adjustable Range 200–350 VDC) | | |
| MPPT Voltage Range | 140–1,000 VDC | | |
| MPPT Range (Full Load) | 380–850 VDC | 420–850 VDC | 480–850 VDC |
| MPPT Tracker/Strings | 2 | | |
| Max. Continuous PV Input Current | 15 ADC × 2 | | |
| Isc PV | 20 ADC × 2 | | |
| Max. Backfeed Current | 0 ADC | | |
| Max. Continuous PV Input Power | 16,000 W | 20,000 W | 20,000 W |

12.4 Grid Terminal Input/Output

| | E8KT | E10KT | E12KT |
|---|-------------------------|-----------|-----------|
| Rated Voltage | 230/400 VAC | | |
| Rated Frequency | 50 Hz /60 Hz | | |
| Maximum Continuous Input Current | 25 AAC | | |
| Maximum Continuous Input Power | 16,000 W | 17,800 W | 17,800 W |
| Rated Output Current | 11.6 AAC | 14.5 AAC | 17.4 AAC |
| Maximum Continuous Output Current | 12.8 AAC | 16 AAC | 19.2 AAC |
| Power factor (Cos phi), Adjustable | 0.8 leading–0.8 lagging | | |
| Rated Output Power | 8,000 W | 10,000 W | 12,000 W |
| Maximum Continuous Output Apparent Power | 8,800 VA | 11,000 VA | 13,200 VA |
| Grid Port Overcurrent Protection | 32 A | | |

12.5 Backup Load Terminal Output

| | E8KT | E10KT | E12KT |
|---|-------------|-----------|-----------|
| Rated Voltage | 230/400 VAC | | |
| Rated frequency | 50 Hz/60 Hz | | |
| Rated Output Current | 10.7 AAC | 13.3 AAC | 13.3 AAC |
| Maximum Continuous Output Current | 11.6 AAC | 14.5 AAC | 14.5 AAC |
| Rated Continuous Output Power | 7,360 W | 9,200 W | 9,200 W |
| Maximum Output Apparent Power | 8,000 VA | 10,000 VA | 10,000 VA |
| Backup Load Overcurrent Protection | 25 A | | |

12.6 Battery Pack (PACK5.1)

| | |
|----------------------------------|-----------------|
| Dimension (W × H × D, mm) | 540 × 530 × 240 |
| Net Weight (kg) | 54 |
| Battery Type | LFP (LiFePO4) |
| IP Protection | IP65 |

| | |
|------------------------------------|---|
| Safety (Cell) | <ul style="list-style-type: none"> • IEC 62619 • UL 1973 • UN 38.3 |
| Warranty | <ul style="list-style-type: none"> • 5-year Product Warranty • 10-year Performance Warranty |
| Operating Temperature Range | <p>Not in heating film:</p> <ul style="list-style-type: none"> • Charge: 0°C to +50°C • Discharge: -10°C to +50°C <p>In heating film:</p> <ul style="list-style-type: none"> • Charge: -10°C to +50°C • Discharge: -10°C to +50°C |
| Operating Relative Humidity | 0–95% (No condensation) |
| Energy Capacity | 5.12 kWh |
| Rated Voltage | 51.2 V |
| Depth of Discharge (DOD) | 90% |
| Operating Voltage Range | 44.8–56.5 VDC |
| Maximum Charging Current | 50 A (0.5C) |
| Maximum Discharging Current | 80 A (0.8C) |
| BMS Modules Connection | A maximum of 8 batteries in parallel |
| BMS Monitoring Parameters | <ul style="list-style-type: none"> • System voltage • System current • Cell voltage • Cell temperature • PCBA temperature measurement |
| Communication | CAN and RS-485 compatible |
| Ventilation Type | Passive Cooling |

12.7 Parallel Connector Box

| | |
|------------------------------|--------------------|
| Dimension (W×H×D, mm) | 105 × 51.5 × 140.4 |
| Net Weight (kg) | 0.45 |
| IP Protection | IP65 |

13 Abbreviations

A

| | |
|------|-------------------------------|
| AC | Alternating Current |
| AFCI | Arc-Fault Circuit-Interrupter |
| App | Application |
| AWG | American Wire Gauge |

B

| | |
|------|-------------------------------|
| BESS | Battery Energy Storage System |
| BMS | Battery Management System |

C

| | |
|----|---------------------|
| CT | Current Transformer |
|----|---------------------|

D

| | |
|------|---------------------------------|
| DC | Direct Current |
| DOD | Depth of Discharge |
| DRED | Demand Response Enabling Device |
| DRM | Demand Response Mode |
| DSP | Digital Signal Processor |

E

| | |
|-----|------------------------------|
| EMI | Electromagnetic Interference |
| EMS | Energy Management System |
| EPS | Emergency Power Supply |

G

| | |
|------|----------------------------------|
| GFCI | Ground Fault Circuit Interrupter |
|------|----------------------------------|

I

| | |
|-----|------------|
| ISO | Insulation |
|-----|------------|

M

| | |
|------|-----------------------------|
| MPPT | Maximum Power Point Tracker |
|------|-----------------------------|

P

| | |
|----|--------------|
| PV | Photovoltaic |
|----|--------------|

R

| | |
|------|-------------------------------|
| RCD | Residual Current Device |
| RESP | Response |
| RRCR | Radio Ripple Control Receiver |

S

| | |
|-----|--------------------------------|
| SCI | Serial Communication Interface |
| SOC | State of Charge |

14 Appendix: Definition of DVC

| Decisive voltage Classification (DVC) | Limits of working voltage V | | |
|---------------------------------------|-------------------------------|------------------------------|-----------------------------|
| | a.c. voltage r.m.s. U_{ACL} | a.c. voltage peak U_{ACPL} | d.c. voltage mean U_{DCL} |
| A* | 25 (16) | 35.4 (22.6) | 60 (35) |
| B | 50 (33) | 71 (46.7) | 120 (70) |
| C | > 50 (> 33) | > 71 (> 46.7) | > 120 (> 70) |

The table values in parentheses are to be used for PCE or portions of PCEs rated for installation in wet locations as addressed in 6.1 for environmental categories and minimum environmental conditions.
 *DVC-A circuits are allowed under fault conditions to have voltages up to the DVC- B limits, for maximum 0.2 s.

